

PHILIPPINE BIDDING DOCUMENTS

PROCUREMENT OF GOODS AND SERVICES FOR THE FABRICATION AND DELIVERY OF FIBERGLASS REINFORCED PLASTIC (FRP) MOTORIZED FISHING BOAT FOR CY 2025



Bureau of Fisheries and Aquatic Resources Regional Fisheries Office I
(Procuring Entity)
Government Center, Sevilla, San Fernando City, La Union

Table of Contents

Glossary of Acronyms, Terms, and Abbreviations	2
Section I. Invitation to Bid.....	5
Section II. Instructions to Bidders.....	7
1. Scope of Bid	9
2. Funding Information.....	9
3. Bidding Requirements	9
4. Corrupt, Fraudulent, Collusive, and Coercive Practices.....	9
5. Eligible Bidders.....	9
6. Origin of Goods	10
7. Subcontracts	10
8. Pre-Bid Conference	10
9. Clarification and Amendment of Bidding Documents	10
10. Documents comprising the Bid: Eligibility and Technical Components	10
11. Documents comprising the Bid: Financial Component	11
12. Bid Prices	11
13. Bid and Payment Currencies	12
14. Bid Security	12
15. Sealing and Marking of Bids	12
16. Deadline for Submission of Bids	12
17. Opening and Preliminary Examination of Bids	13
18. Domestic Preference	13
19. Detailed Evaluation and Comparison of Bids	13
20. Post-Qualification	14
21. Signing of the Contract	14
Section III. Bid Data Sheet	15
Section IV. General Conditions of Contract	17
1. Scope of Contract	18
2. Advance Payment and Terms of Payment	18
3. Performance Security	18
4. Inspection and Tests	18
5. Warranty	19
6. Liability of the Supplier	19
Section V. Special Conditions of Contract	20
Section VI. Schedule of Requirements	25
Section VII. Technical Specifications	26
Section VIII. Checklist of Technical and Financial Documents	28

Glossary of Acronyms, Terms, and Abbreviations

ABC – Approved Budget for the Contract.

BAC – Bids and Awards Committee.

Bid – A signed offer or proposal to undertake a contract submitted by a bidder in response to and in consonance with the requirements of the bidding documents. Also referred to as *Proposal* and *Tender*. (2016 revised IRR, Section 5[c])

Bidder – Refers to a contractor, manufacturer, supplier, distributor and/or consultant who submits a bid in response to the requirements of the Bidding Documents. (2016 revised IRR, Section 5[d])

Bidding Documents – The documents issued by the Procuring Entity as the bases for bids, furnishing all information necessary for a prospective bidder to prepare a bid for the Goods, Infrastructure Projects, and/or Consulting Services required by the Procuring Entity. (2016 revised IRR, Section 5[e])

BIR – Bureau of Internal Revenue.

BSP – Bangko Sentral ng Pilipinas.

Consulting Services – Refer to services for Infrastructure Projects and other types of projects or activities of the GOP requiring adequate external technical and professional expertise that are beyond the capability and/or capacity of the GOP to undertake such as, but not limited to: (i) advisory and review services; (ii) pre-investment or feasibility studies; (iii) design; (iv) construction supervision; (v) management and related services; and (vi) other technical services or special studies. (2016 revised IRR, Section 5[i])

CDA - Cooperative Development Authority.

Contract – Refers to the agreement entered into between the Procuring Entity and the Supplier or Manufacturer or Distributor or Service Provider for procurement of Goods and Services; Contractor for Procurement of Infrastructure Projects; or Consultant or Consulting Firm for Procurement of Consulting Services; as the case may be, as recorded in the Contract Form signed by the parties, including all attachments and appendices thereto and all documents incorporated by reference therein.

CIF – Cost Insurance and Freight.

CIP – Carriage and Insurance Paid.

CPI – Consumer Price Index.

DDP – Refers to the quoted price of the Goods, which means “delivered duty paid.”

DTI – Department of Trade and Industry.

EXW – Ex works.

FCA – “Free Carrier” shipping point.

FOB – “Free on Board” shipping point.

Foreign-funded Procurement or Foreign-Assisted Project– Refers to procurement whose funding source is from a foreign government, foreign or international financing institution as specified in the Treaty or International or Executive Agreement. (2016 revised IRR, Section 5[b]).

Framework Agreement – Refers to a written agreement between a procuring entity and a supplier or service provider that identifies the terms and conditions, under which specific purchases, otherwise known as “Call-Offs,” are made for the duration of the agreement. It is in the nature of an option contract between the procuring entity and the bidder(s) granting the procuring entity the option to either place an order for any of the goods or services identified in the Framework Agreement List or not buy at all, within a minimum period of one (1) year to a maximum period of three (3) years. (GPPB Resolution No. 27-2019)

GFI – Government Financial Institution.

GOCC – Government-owned and/or –controlled corporation.

Goods – Refer to all items, supplies, materials and general support services, except Consulting Services and Infrastructure Projects, which may be needed in the transaction of public businesses or in the pursuit of any government undertaking, project or activity, whether in the nature of equipment, furniture, stationery, materials for construction, or personal property of any kind, including non-personal or contractual services such as the repair and maintenance of equipment and furniture, as well as trucking, hauling, janitorial, security, and related or analogous services, as well as procurement of materials and supplies provided by the Procuring Entity for such services. The term “related” or “analogous services” shall include, but is not limited to, lease or purchase of office space, media advertisements, health maintenance services, and other services essential to the operation of the Procuring Entity. (2016 revised IRR, Section 5[r])

GOP – Government of the Philippines.

GPPB – Government Procurement Policy Board.

INCOTERMS – International Commercial Terms.

Infrastructure Projects – Include the construction, improvement, rehabilitation, demolition, repair, restoration or maintenance of roads and bridges, railways, airports, seaports, communication facilities, civil works components of information technology projects, irrigation, flood control and drainage, water supply, sanitation, sewerage and solid waste management systems, shore protection, energy/power and electrification facilities, national

buildings, school buildings, hospital buildings, and other related construction projects of the government. Also referred to as *civil works or works*. (2016 revised IRR, Section 5[u])

LGUs – Local Government Units.

NFCC – Net Financial Contracting Capacity.

NGA – National Government Agency.

PhilGEPS - Philippine Government Electronic Procurement System.

Procurement Project – refers to a specific or identified procurement covering goods, infrastructure project or consulting services. A Procurement Project shall be described, detailed, and scheduled in the Project Procurement Management Plan prepared by the agency which shall be consolidated in the procuring entity's Annual Procurement Plan. (GPPB Circular No. 06-2019 dated 17 July 2019)

PSA – Philippine Statistics Authority.

SEC – Securities and Exchange Commission.

SLCC – Single Largest Completed Contract.

Supplier – refers to a citizen, or any corporate body or commercial company duly organized and registered under the laws where it is established, habitually established in business and engaged in the manufacture or sale of the merchandise or performance of the general services covered by his bid. (Item 3.8 of GPPB Resolution No. 13-2019, dated 23 May 2019). Supplier as used in these Bidding Documents may likewise refer to a distributor, manufacturer, contractor, or consultant.

UN – United Nations.

Section I. Invitation to Bid



Republic of the Philippines
DEPARTMENT OF AGRICULTURE
BUREAU OF FISHERIES AND AQUATIC RESOURCES
Regional Fisheries Office No. 1
Government Center, Sevilla, San Fernando City, La Union 2500
Telefax: (072) 242-15-59 Tel. No.: (072) 607-5115
E-mail: bfarfo1_records@bfar.da.gov.ph / bfarfo1_records@yahoo.com
Help Stop Illegal Fishing! Report to Bantay Dagat Hotline: SMART: 0919-996-1078

INVITATION TO BID FOR THE PROCUREMENT OF GOODS AND SERVICES FOR THE FABRICATION AND DELIVERY OF FIBERGLASS REINFORCED PLASTIC (FRP) MOTORIZED FISHING FOR CY 2025

1. The *Bureau of Fisheries and Aquatic Resources-Regional Fisheries Office I (BFAR RFO I)*, through the *General Appropriation Act of 2025 (GAA 2025)* intends to apply the sum of Two Million Three Hundred Three Thousand Forty Pesos (P2,303,040.00) being the ABC to payments under the contract for the procurement of goods and services for the fabrication and delivery of fiberglass reinforced plastic motorized fishing boats for CY 2025. Bids received in excess of the ABC shall be automatically rejected at bid opening.
2. The *BFAR RFO I* now invites bids for the above Procurement Project. Delivery of the Goods is required within seventy five (75) calendar days as indicated in Section VI. Schedule of Requirements. Bidders should have completed, within *three (3) years* from the date of submission and receipt of bids, a contract similar to the Project. The description of an eligible bidder is contained in the Bidding Documents, particularly, in Section II (Instructions to Bidders).
3. Bidding will be conducted through open competitive bidding procedures using a non-discretionary “*pass/fail*” criterion as specified in the 2016 revised Implementing Rules and Regulations (IRR) of Republic Act (RA) No. 9184.
 - a. Bidding is restricted to Filipino citizens/sole proprietorships, partnerships, or organizations with at least sixty percent (60%) interest or outstanding capital stock belonging to citizens of the Philippines, and to citizens or organizations of a country the laws or regulations of which grant similar rights or privileges to Filipino citizens, pursuant to RA No. 5183.
4. Prospective Bidders may obtain further information from *the Bids and Awards Committee (BAC) Secretariat* and inspect the Bidding Documents at the address given below during *Monday to Friday; 8:00 AM to 5:00 PM*.
5. A complete set of Bidding Documents may be acquired by interested Bidders on *January 22, 2025* from the given address and website(s) below *and upon payment of the applicable fee for the Bidding Documents, pursuant to the latest Guidelines issued by the GPPB, in the amount of Five Thousand Pesos (P5,000.00)* The Procuring Entity shall allow the bidder to present its proof of payment for the fees *in person, by facsimile, or through electronic means*.
6. The *BFAR-RFO I* will hold a Pre-Bid Conference on **January 30, 2025; 11:30 AM** at *BFAR-Regional Office I, Sevilla San Fernando City, La Union* and/or through video conferencing or webcasting *via zoomlink*, which shall be open to prospective bidders.

7. Bids must be duly received by the BAC Secretariat through manual submission at the office address indicated below, on or before ***February 12, 2025; 9:00 AM***. Late bids shall not be accepted.
8. All Bids must be accompanied by a bid security in any of the acceptable forms and in the amount stated in **ITB** Clause 14.
9. Bid opening shall be on ***February 12, 2025; 11:30 AM***. Bids will be opened in the presence of the bidders' representatives who choose to attend the activity.
10. The ***BFAR RFO I*** reserves the right to reject any and all bids, declare a failure of bidding, or not award the contract at any time prior to contract award in accordance with Sections 35.6 and 41 of the 2016 revised IRR of RA No. 9184, without thereby incurring any liability to the affected bidder or bidders.
11. For further information, please refer to:

Melanie D. Palencia

Head-BAC Secretariat

BFAR RFO I, Government Center, Sevilla, San Fernando City, La Union

(072)-242-1559

Email Addresses: bac_bfar1@yahoo.com.ph or bacbfar1@gmail.com

Webpage: <https://region1.bfar.da.gov.ph>

12. You may visit the following website:
For downloading of Bidding Documents: <https://region1.bfar.da.gov.ph>

January 22, 2025

ATTY. GIRLY G. DELA PENA, CESE

Chairperson

Bids and Awards Committee

Section II. Instructions to Bidders

1. Scope of Bid

The Procuring Entity, *Bureau of Fisheries and Aquatic Resources-Regional Fisheries office I (BFAR-RFO I)* wishes to receive Bids for the *Procurement of Goods and Services for the Fabrication of Fiberglass Reinforced Plastic (FRP) Motorized Fishing Boats* with identification number *ITB No. 2025-013*.

The Procurement Project (referred to herein as “Project”) is composed of *one (1) lot* the details of which are described in Section VII (Technical Specifications).

2. Funding Information

2.1. The GOP through the source of funding as indicated below for GAA 2025 in the amount of Two Million Three Hundred Three Thousand Forty Pesos (P2,303,040.00).

2.2. The source of funding is General Appropriation Act of 2025.

3. Bidding Requirements

The Bidding for the Project shall be governed by all the provisions of RA No. 9184 and its 2016 revised IRR, including its Generic Procurement Manuals and associated policies, rules and regulations as the primary source thereof, while the herein clauses shall serve as the secondary source thereof.

Any amendments made to the IRR and other GPPB issuances shall be applicable only to the ongoing posting, advertisement, or **IB** by the BAC through the issuance of a supplemental or bid bulletin.

The Bidder, by the act of submitting its Bid, shall be deemed to have verified and accepted the general requirements of this Project, including other factors that may affect the cost, duration and execution or implementation of the contract, project, or work and examine all instructions, forms, terms, and project requirements in the Bidding Documents.

4. Corrupt, Fraudulent, Collusive, and Coercive Practices

The Procuring Entity, as well as the Bidders and Suppliers, shall observe the highest standard of ethics during the procurement and execution of the contract. They or through an agent shall not engage in corrupt, fraudulent, collusive, coercive, and obstructive practices defined under Annex “I” of the 2016 revised IRR of RA No. 9184 or other integrity violations in competing for the Project.

5. Eligible Bidders

5.1. Only Bids of Bidders found to be legally, technically, and financially capable will be evaluated.

- 5.2. Foreign ownership limited to those allowed under the rules may participate in this Project.
- 5.3. Pursuant to Section 23.4.1.3 of the 2016 revised IRR of RA No.9184, the Bidder shall have an SLCC that is at least one (1) contract similar to the Project the value of which, adjusted to current prices using the PSA's CPI, must be at least equivalent to:
 - a. The Bidder must have completed a single contract that is similar to this Project, equivalent to at least fifty percent (50%) of the ABC.
- 5.4. The Bidders shall comply with the eligibility criteria under Section 23.4.1 of the 2016 IRR of RA No. 9184.

6. Origin of Goods

There is no restriction on the origin of goods other than those prohibited by a decision of the UN Security Council taken under Chapter VII of the Charter of the UN, subject to Domestic Preference requirements under **ITB** Clause 18.

7. Subcontracts

7.1. The Procuring Entity has prescribed that **Subcontracting is not allowed.**

8. Pre-Bid Conference

The Procuring Entity will hold a pre-bid conference for this Project on the specified date and time and either at its physical address and/or through videoconferencing/webcasting as indicated in paragraph 6 of the **IB**.

9. Clarification and Amendment of Bidding Documents

Prospective bidders may request for clarification on and/or interpretation of any part of the Bidding Documents. Such requests must be in writing and received by the Procuring Entity, either at its given address or through electronic mail indicated in the **IB**, at least ten (10) calendar days before the deadline set for the submission and receipt of Bids.

10. Documents comprising the Bid: Eligibility and Technical Components

- 10.1. The first envelope shall contain the eligibility and technical documents of the Bid as specified in **Section VIII (Checklist of Technical and Financial Documents)**.
- 10.2. The Bidder's SLCC as indicated in **ITB** Clause 5.3 should have been completed within *three (3) years* prior to the deadline for the submission and receipt of bids.

- 10.3. If the eligibility requirements or statements, the bids, and all other documents for submission to the BAC are in foreign language other than English, it must be accompanied by a translation in English, which shall be authenticated by the appropriate Philippine foreign service establishment, post, or the equivalent office having jurisdiction over the foreign bidder's affairs in the Philippines. Similar to the required authentication above, for Contracting Parties to the Apostille Convention, only the translated documents shall be authenticated through an apostille pursuant to GPPB Resolution No. 13-2019 dated 23 May 2019. The English translation shall govern, for purposes of interpretation of the bid.

11. Documents comprising the Bid: Financial Component

- 11.1. The second bid envelope shall contain the financial documents for the Bid as specified in **Section VIII (Checklist of Technical and Financial Documents)**.
- 11.2. If the Bidder claims preference as a Domestic Bidder or Domestic Entity, a certification issued by DTI shall be provided by the Bidder in accordance with Section 43.1.3 of the 2016 revised IRR of RA No. 9184.
- 11.3. Any bid exceeding the ABC indicated in paragraph 1 of the **IB** shall not be accepted.

12. Bid Prices

- 12.1. Prices indicated on the Price Schedule shall be entered separately in the following manner:
 - a. For Goods offered from within the Procuring Entity's country:
 - i. The price of the Goods quoted EXW (ex-works, ex-factory, ex-warehouse, ex-showroom, or off-the-shelf, as applicable);
 - ii. The cost of all customs duties and sales and other taxes already paid or payable;
 - iii. The cost of transportation, insurance, and other costs incidental to delivery of the Goods to their final destination; and
 - iv. The price of other (incidental) services, if any, listed in the **BDS**.
 - b. For Goods offered from abroad:
 - i. Unless otherwise stated in the **BDS**, the price of the Goods shall be quoted delivered duty paid (DDP) with the place of destination in the Philippines as specified in the **BDS**. In quoting the price, the Bidder shall be free to use transportation through carriers registered in any eligible country. Similarly, the Bidder may obtain insurance services from any eligible source country.

- ii. The price of other (incidental) services, if any, as listed in the **BDS**.

13. Bid and Payment Currencies

- 13.1. For Goods that the Bidder will supply from outside the Philippines, the bid prices may be quoted in the local currency or tradeable currency accepted by the BSP at the discretion of the Bidder. However, for purposes of bid evaluation, Bids denominated in foreign currencies, shall be converted to Philippine currency based on the exchange rate as published in the BSP reference rate bulletin on the day of the bid opening.
- 13.2. Payment of the contract price shall be made in:
 - a. Philippine Pesos.

14. Bid Security

- 14.1. The Bidder shall submit a Bid Securing Declaration or any form of Bid Security in the amount indicated in the **BDS**, which shall be not less than the percentage of the ABC in accordance with the schedule in the **BDS**.
- 14.2. The Bid and bid security shall be valid until *one hundred twenty (120) calendar days*. Any Bid not accompanied by an acceptable bid security shall be rejected by the Procuring Entity as non-responsive.

15. Sealing and Marking of Bids

Each Bidder shall submit one copy of the first and second components of its Bid.

The Procuring Entity may request additional hard copies and/or electronic copies of the Bid. However, failure of the Bidders to comply with the said request shall not be a ground for disqualification.

If the Procuring Entity allows the submission of bids through online submission or any other electronic means, the Bidder shall submit an electronic copy of its Bid, which must be digitally signed. An electronic copy that cannot be opened or is corrupted shall be considered non-responsive and, thus, automatically disqualified.

16. Deadline for Submission of Bids

- 16.1. The Bidders shall submit on the specified date and time and either at its physical address or through online submission as indicated in paragraph 7 of the **IB**.

17. Opening and Preliminary Examination of Bids

- 17.1. The BAC shall open the Bids in public at the time, on the date, and at the place specified in paragraph 9 of the **IB**. The Bidders' representatives who are present shall sign a register evidencing their attendance. In case videoconferencing, webcasting or other similar technologies will be used, attendance of participants shall likewise be recorded by the BAC Secretariat.

In case the Bids cannot be opened as scheduled due to justifiable reasons, the rescheduling requirements under Section 29 of the 2016 revised IRR of RA No. 9184 shall prevail.

- 17.2. The preliminary examination of bids shall be governed by Section 30 of the 2016 revised IRR of RA No. 9184.

18. Domestic Preference

- 18.1. The Procuring Entity will grant a margin of preference for the purpose of comparison of Bids in accordance with Section 43.1.2 of the 2016 revised IRR of RA No. 9184.

19. Detailed Evaluation and Comparison of Bids

- 19.1. The Procuring Entity's BAC shall immediately conduct a detailed evaluation of all Bids rated "*passed*," using non-discretionary pass/fail criteria. The BAC shall consider the conditions in the evaluation of Bids under Section 32.2 of the 2016 revised IRR of RA No. 9184.

- 19.2. If the Project allows partial bids, bidders may submit a proposal on any of the lots or items, and evaluation will be undertaken on a per lot or item basis, as the case maybe. In this case, the Bid Security as required by **ITB** Clause 14 shall be submitted for each lot or item separately.

- 19.3. The descriptions of the lots or items shall be indicated in **Section VII (Technical Specifications)**, although the ABCs of these lots or items are indicated in the **BDS** for purposes of the NFCC computation pursuant to Section 23.4.2.6 of the 2016 revised IRR of RA No. 9184. The NFCC must be sufficient for the total of the ABCs for all the lots or items participated in by the prospective Bidder.

- 19.4. The Project shall be awarded as follows:

One Project having several items that shall be awarded as one contract.

- 19.5. Except for bidders submitting a committed Line of Credit from a Universal or Commercial Bank in lieu of its NFCC computation, all Bids must include the NFCC computation pursuant to Section 23.4.1.4 of the 2016 revised IRR of RA No. 9184, which must be sufficient for the total of the ABCs for all the lots or items participated in by the prospective Bidder. For bidders submitting

the committed Line of Credit, it must be at least equal to ten percent (10%) of the ABCs for all the lots or items participated in by the prospective Bidder.

20. Post-Qualification

- 20.2. Within a non-extendible period of five (5) calendar days from receipt by the Bidder of the notice from the BAC that it submitted the Lowest Calculated Bid, or in the case of multi-year Framework Agreement, that it is one of the eligible bidders who have submitted bids that are found to be technically and financially compliant, }the Bidder shall submit its latest income and business tax returns filed and paid through the BIR Electronic Filing and Payment System (eFPS) and other appropriate licenses and permits required by law and stated in the **BDS**.

21. Signing of the Contract

- 21.1. The documents required in Section 37.2 of the 2016 revised IRR of RA No. 9184 shall form part of the Contract. Additional Contract documents are indicated in the **BDS**.

Section III. Bid Data Sheet

Bid Data Sheet

ITB Clause	
5.3	For this purpose, contracts similar to the Project shall be: <ul style="list-style-type: none"> a. <i>Lot 1: Fabrication fiberglass reinforced plastic (FRP) Motorized Boat</i> b. completed within three (3) years prior to the deadline for the submission and receipt of bids.
7.1	<i>Subcontracting is not allowed.</i>
12	The price of the Goods shall be quoted DDP <i>onsite</i> or the applicable International Commercial Terms (INCOTERMS) for this Project.
14.1	The bid security shall be in the form of a Bid Securing Declaration, or any of the following forms and amounts: <ul style="list-style-type: none"> a. The amount of not less than Forty Thousand Sixty Pesos and 8/100 (P46,060.80), if bid security is in cash, cashier's/manager's check, bank draft/guarantee or irrevocable letter of credit; or b. The amount of not less than One Hundred Fifteen Thousand One Hundred Fifty Two Pesos (P115,152.00), if bid security is in Surety Bond.
19.3	<i>The contract will be awarded as one contract</i>
20.2	Latest income and business tax returns filed and paid through the BIR Electronic Filing and Payment System (eFPS) <i>Registration Certificate as Accredited Boat Manufacturer/fabricator (Contractor must be MARINA Registered Boat Builder)</i>
21.2	<i>No further instructions</i>

Section IV. General Conditions of Contract

1. **Scope of Contract**

This Contract shall include all such items, although not specifically mentioned, that can be reasonably inferred as being required for its completion as if such items were expressly mentioned herein. All the provisions of RA No. 9184 and its 2016 revised IRR, including the Generic Procurement Manual, and associated issuances, constitute the primary source for the terms and conditions of the Contract, and thus, applicable in contract implementation. Herein clauses shall serve as the secondary source for the terms and conditions of the Contract.

This is without prejudice to Sections 74.1 and 74.2 of the 2016 revised IRR of RA No. 9184 allowing the GPPB to amend the IRR, which shall be applied to all procurement activities, the advertisement, posting, or invitation of which were issued after the effectivity of the said amendment.

Additional requirements for the completion of this Contract shall be provided in the **Special Conditions of Contract (SCC)**.

2. **Advance Payment and Terms of Payment**

2.1. Advance payment of the contract amount is provided under Annex “D” of the revised 2016 IRR of RA No. 9184.

2.2. The Procuring Entity is allowed to determine the terms of payment on the partial or staggered delivery of the Goods procured, provided such partial payment shall correspond to the value of the goods delivered and accepted in accordance with prevailing accounting and auditing rules and regulations. The terms of payment are indicated in the **SCC**.

3. **Performance Security**

Within ten (10) calendar days from receipt of the Notice of Award by the Bidder from the Procuring Entity but in no case later than the signing of the Contract by both parties, the successful Bidder shall furnish the performance security in any of the forms prescribed in Section 39 of the 2016 revised IRR of RA No. 9184

4. **Inspection and Tests**

The Procuring Entity or its representative shall have the right to inspect and/or to test the Goods to confirm their conformity to the Project specifications at no extra cost to the Procuring Entity in accordance with the Generic Procurement Manual. In addition to tests in the **SCC, Section VII (Technical Specifications)** shall specify what inspections and/or tests the Procuring Entity requires, and where they are to be conducted. The Procuring Entity shall notify the Supplier in writing, in a timely manner, of the identity of any representatives retained for these purposes.

All reasonable facilities and assistance for the inspection and testing of Goods, including access to drawings and production data, shall be provided by the Supplier to the authorized inspectors at no charge to the Procuring Entity.

5. Warranty

- 5.1 In order to assure that manufacturing defects shall be corrected by the Supplier, a warranty shall be required from the Supplier as provided under Section 62.1 of the 2016 revised IRR of RA No. 9184.
- 5.2 The Procuring Entity shall promptly notify the Supplier in writing of any claims arising under this warranty. Upon receipt of such notice, the Supplier shall, repair or replace the defective Goods or parts thereof without cost to the Procuring Entity, pursuant to the Generic Procurement Manual.

6. Liability of the Supplier

The Supplier's liability under this Contract shall be as provided by the laws of the Republic of the Philippines.

If the Supplier is a joint venture, all partners to the joint venture shall be jointly and severally liable to the Procuring Entity.

Section V. Special Conditions of Contract

Special Conditions of Contract

GCC Clause	
1	<p>Delivery and Documents –</p> <p>For purposes of the Contract, “EXW,” “FOB,” “FCA,” “CIF,” “CIP,” “DDP” and other trade terms used to describe the obligations of the parties shall have the meanings assigned to them by the current edition of INCOTERMS published by the International Chamber of Commerce, Paris. The Delivery terms of this Contract shall be as follows:</p> <p>“The delivery terms applicable to this Contract are delivered <i>onsite as specified in Section VI. Schedule of Requirements</i>. Risk and title will pass from the Supplier to the Procuring Entity upon receipt and final acceptance of the Goods at their final destination.”</p> <p>Delivery of the Goods shall be made by the Supplier in accordance with the terms specified in Section VI (Schedule of Requirements).</p> <p>For purposes of this Clause the Procuring Entity’s Representative at the Project Site are:</p> <ul style="list-style-type: none"> • <i>Ms. Remely B. Lachica – Chief FPSSD</i> • <i>Mr. Henry Q. Canlas- Head Production Section</i> • <i>PFOs</i> • <i>Property Unit</i> <p>Incidental Services –</p> <p>The Supplier is required to provide all of the following services, including additional services, if any, specified in Section VI. Schedule of Requirements:</p> <ol style="list-style-type: none"> a. performance or supervision of on-site assembly and/or start-up of the supplied Goods; b. furnishing of tools required for assembly and/or maintenance of the supplied Goods; c. furnishing of a detailed operations and maintenance manual for each appropriate unit of the supplied Goods; d. performance or supervision or maintenance and/or repair of the supplied Goods, for a period of time agreed by the parties, provided that this service shall not relieve the Supplier of any warranty obligations under this Contract; and
	<ol style="list-style-type: none"> e. training of the Procuring Entity’s personnel, at the Supplier’s plant and/or on-site, in assembly, start-up, operation, maintenance, and/or repair of the supplied Goods. <p>The Contract price for the Goods shall include the prices charged by the Supplier for incidental services and shall not exceed the prevailing rates charged to other parties by the Supplier for similar services.</p>

	<p>Spare Parts –</p> <p>The Supplier is required to provide all of the following materials, notifications, and information pertaining to spare parts manufactured or distributed by the Supplier:</p> <ol style="list-style-type: none"> 1. such spare parts as the Procuring Entity may elect to purchase from the Supplier, provided that this election shall not relieve the Supplier of any warranty obligations under this Contract; and 2. in the event of termination of production of the spare parts: <ol style="list-style-type: none"> i. advance notification to the Procuring Entity of the pending termination, in sufficient time to permit the Procuring Entity to procure needed requirements; and ii. following such termination, furnishing at no cost to the Procuring Entity, the blueprints, drawings, and specifications of the spare parts, if requested. <p>The spare parts and other components required are listed in Section VI (Schedule of Requirements) and the costs thereof are included in the contract price.</p> <p>The Supplier shall carry sufficient inventories to assure ex-stock supply of consumable spare parts or components for the Goods for a period of one to 3 years.</p> <p>Spare parts or components shall be supplied as promptly as possible, but in any case, within one to two (1-2) months of placing the order.</p>
	<p>Packaging –</p> <p>The Supplier shall provide such packaging of the Goods as is required to prevent their damage or deterioration during transit to their final destination, as indicated in this Contract. The packaging shall be sufficient to withstand, without limitation, rough handling during transit and exposure to extreme temperatures, salt and precipitation during transit, and open storage. Packaging case size and weights shall take into consideration, where appropriate, the remoteness of the Goods' final destination and the absence of heavy handling facilities at all points in transit.</p> <p>The packaging, marking, and documentation within and outside the packages shall comply strictly with such special requirements as shall be expressly provided for in the Contract, including additional requirements, if any, specified below, and in any subsequent instructions ordered by the Procuring Entity.</p>

	<p>The outer packaging must be clearly marked on at least four (4) sides as follows:</p> <p>Name of the Procuring Entity Name of the Supplier Contract Description Final Destination Gross weight Any special lifting instructions Any special handling instructions Any relevant HAZCHEM classifications</p>
	<p>A packaging list identifying the contents and quantities of the package is to be placed on an accessible point of the outer packaging if practical. If not practical the packaging list is to be placed inside the outer packaging but outside the secondary packaging.</p> <p>Transportation –</p> <p>Where the Supplier is required under Contract to deliver the Goods CIF, CIP, or DDP, transport of the Goods to the port of destination or such other named place of destination in the Philippines, as shall be specified in this Contract, shall be arranged and paid for by the Supplier, and the cost thereof shall be included in the Contract Price.</p> <p>Where the Supplier is required under this Contract to transport the Goods to a specified place of destination within the Philippines, defined as the Project Site, transport to such place of destination in the Philippines, including insurance and storage, as shall be specified in this Contract, shall be arranged by the Supplier, and related costs shall be included in the contract price.</p>
	<p>Where the Supplier is required under Contract to deliver the Goods CIF, CIP or DDP, Goods are to be transported on carriers of Philippine registry. In the event that no carrier of Philippine registry is available, Goods may be shipped by a carrier which is not of Philippine registry provided that the Supplier obtains and presents to the Procuring Entity certification to this effect from the nearest Philippine consulate to the port of dispatch. In the event that carriers of Philippine registry are available but their schedule delays the Supplier in its performance of this Contract the period from when the Goods were first ready for shipment and the actual date of shipment the period of delay will be considered force majeure.</p> <p>The Procuring Entity accepts no liability for the damage of Goods during transit other than those prescribed by INCOTERMS for DDP deliveries. In the case of Goods supplied from within the Philippines or supplied by domestic Suppliers risk and title will not be deemed to have passed to the Procuring Entity until their receipt and final acceptance at the final destination.</p>

	<p>Intellectual Property Rights –</p> <p>The Supplier shall indemnify the Procuring Entity against all third-party claims of infringement of patent, trademark, or industrial design rights arising from use of the Goods or any part thereof.</p>
2.2	<p>“The terms of payment shall be as follows: 50% upon partial delivery of goods required subject to submission of requisite documents, and 100% upon full delivery of goods and submission of requisite documents”</p>
4	<p>The inspections and tests that will be conducted are: <i>(1) completeness of parts, (2) conformity to specifications, (3) operating and functioning properly, (4) no defects or damages, (5) conformity to quantities, and (6) conformity to specifications</i></p>

Section VI. Schedule of Requirements

The delivery schedule expressed as weeks/months stipulates hereafter a delivery date which is the date of delivery to the project site.

Item No.	Description	Qty	Total	Delivered, Weeks/Months
1	Start fabrication of Fiberglass Reinforced Plastic (FRP) Motorized Fishing Boat: a) 38-footer FRP Handline Motorized Fishing Boat with underwater fittings	1 unit	1 unit	Within 60 calendar days upon receipt of NTP
	b) 15-footer FRP Motorized Fishing Boat with (Pakura) with underwater fittings <i>Delivery site: Dasol, Pangasinan</i>	6 units	6 units	
	c) 24-footer FRP Motorized Fishing Boat with accessories with underwater fittings Delivery sites: <ul style="list-style-type: none"> • Laoag Ilocos Norte - 4 units • Narvacan, Ilocos Sur - 3 units • Bauang, La Union - 1 unit • San Fernando City, La Union - 1 unit • Burgos, Pangasinan - 1 unit 	10 units	10 units	
2	Delivery of Fabricated FRP Fishing Boat Note: Contractor to send notice at least five (5) days prior to delivery	17 units	17 units	Within 61 to 90 days
2	Inspection of motorized boat	1 lot	1 lot	Within the day of installation
3	Turnover and payment	1 lot	1 lot	Within 7 days from receipt of billing statement with requisite attachments

I hereby certify to comply with all the above Schedule of Requirements

Name of Company/Bidder

Printed Name, Position and Signature of Bidder's Authorized Representative

Date

Section VII. Technical Specifications

Technical Specifications

Item	Specification	Statement of Compliance
1	1 unit 38-footer FRP Handline Motorized Fishing Boat with underwater fittings Delivery Site: Dasol, Pangasinan	
2	6 units 15-footer FRP Motorized Fishing Boat with accessories (Pakura) with underwater fittings Delivery Site: Dasol, Pangasinan	
3	10 units 24 footer FRP Motorized Fishing Boat with underwater fittings Delivery sites: <ul style="list-style-type: none"> • Laoag, Ilocos Norte (4) • Narvacan, Ilocos Sur (3) • Bauang, La Union (1) • San Fernando City, La Union (1) • Burgos, Pangasinan (1) Please see attached detailed specifications and lay-out (Annex 1)	
4	Materials (such as resin, fiberglass mats, etc) to be used should conform with BFAR Standards	
5	Contractor shall be responsible solely for manpower and bear all costs of labor and other expenses during the fabrication and delivery of units	
6	Costs Inclusive of all taxes and other fees	

Bidders must state here either “Comply” or “Not Comply” against each of the individual parameters of each Specification stating the corresponding performance parameter of the equipment offered. Statements of “Comply” or “Not Comply” must be supported by evidence in a Bidders Bid and cross-referenced to that evidence. Evidence shall be in the form of manufacturer’s un-amended sales literature, unconditional statements of specification and compliance issued by the manufacturer, samples, independent test data etc., as appropriate. A statement that is not supported by evidence or is subsequently found to be contradicted by the evidence presented will render the Bid under evaluation liable for rejection. A statement either in the Bidder's statement of compliance or the supporting evidence that is found to be false either during Bid evaluation, post-qualification or the execution of the Contract may be regarded as fraudulent and render the Bidder or supplier liable for prosecution subject to the applicable laws and issuances.

I hereby certify to comply with all the above Schedule of Requirements

Name of Company/Bidder

Printed Name, Position and Signature of Bidder’s Authorized Representative

Date

**ANNEX 1. DETAILED SPECIFICATIONS
AND LAY-OUT**

Fabrication and Delivery of FRP Motorized Boats

1 unit 38-footer FRP Tuna Handliner Motorized Fishing Boat with underwater fittings
Delivery Site: Dasol, Pangasinan

6 units 15-footer FRP Motorized Boat (Pakura) with underwater fittings
Delivery Site: Dasol, Pangasinan

10 units 24-footer FRP Motorized Boat with underwater fittings
Delivery Sites: Laoag, Ilocos Norte (4)
Narvacan, Ilocos Sur (3)
Bauang, La Union (1)
San Fernando City, La Union (1)
Burgos, Pangasinan

Contract Period: 90 CD, delivery starts after 60CD
Implementation Schedule: July 2024

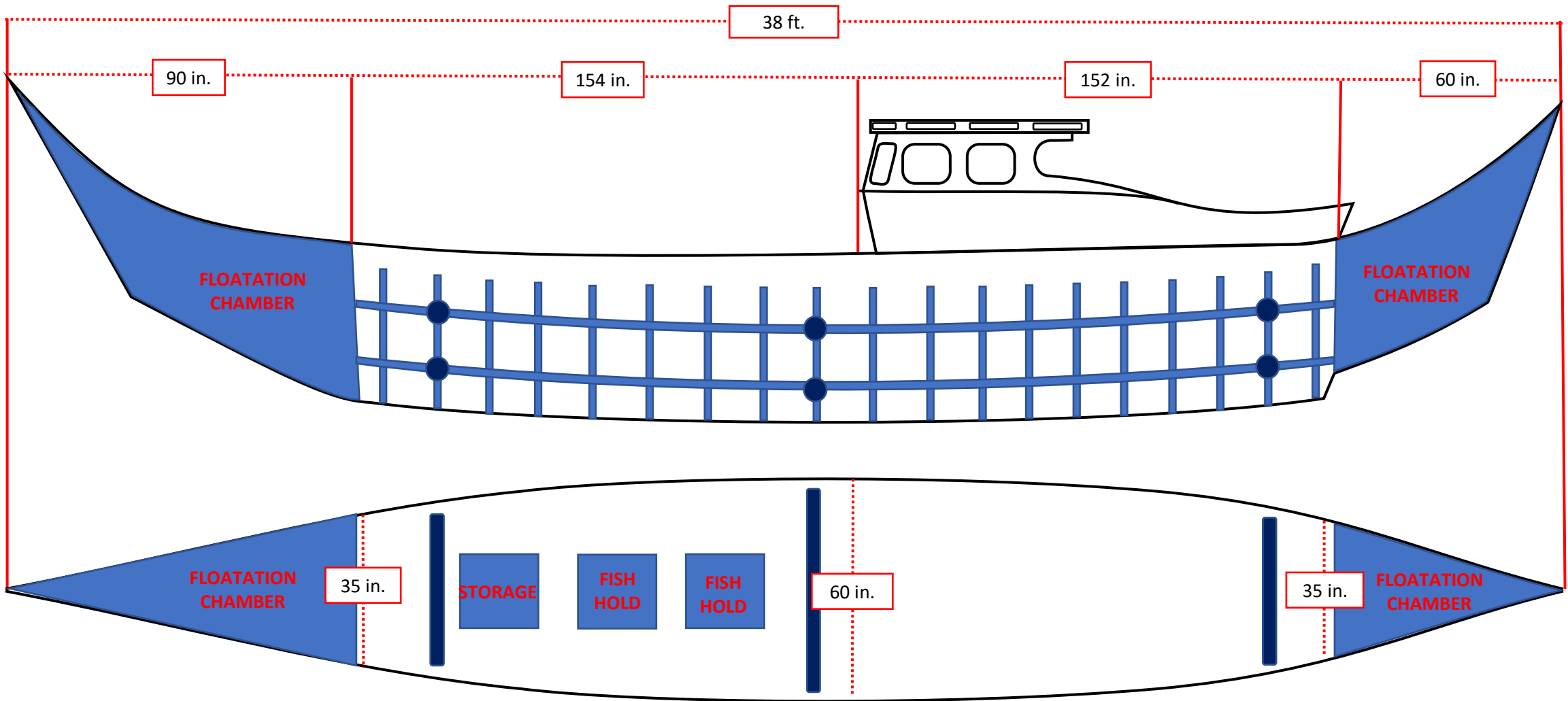

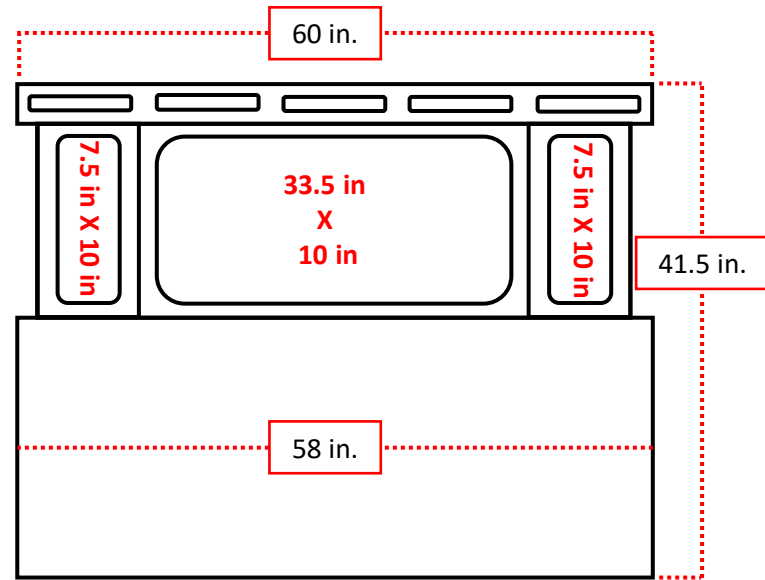
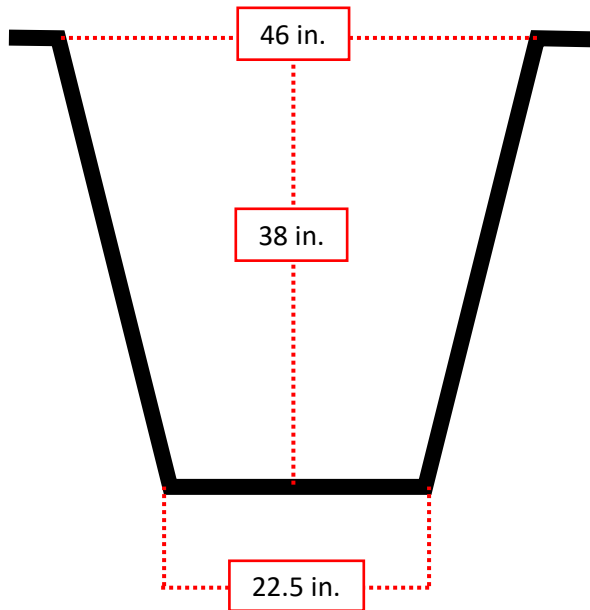
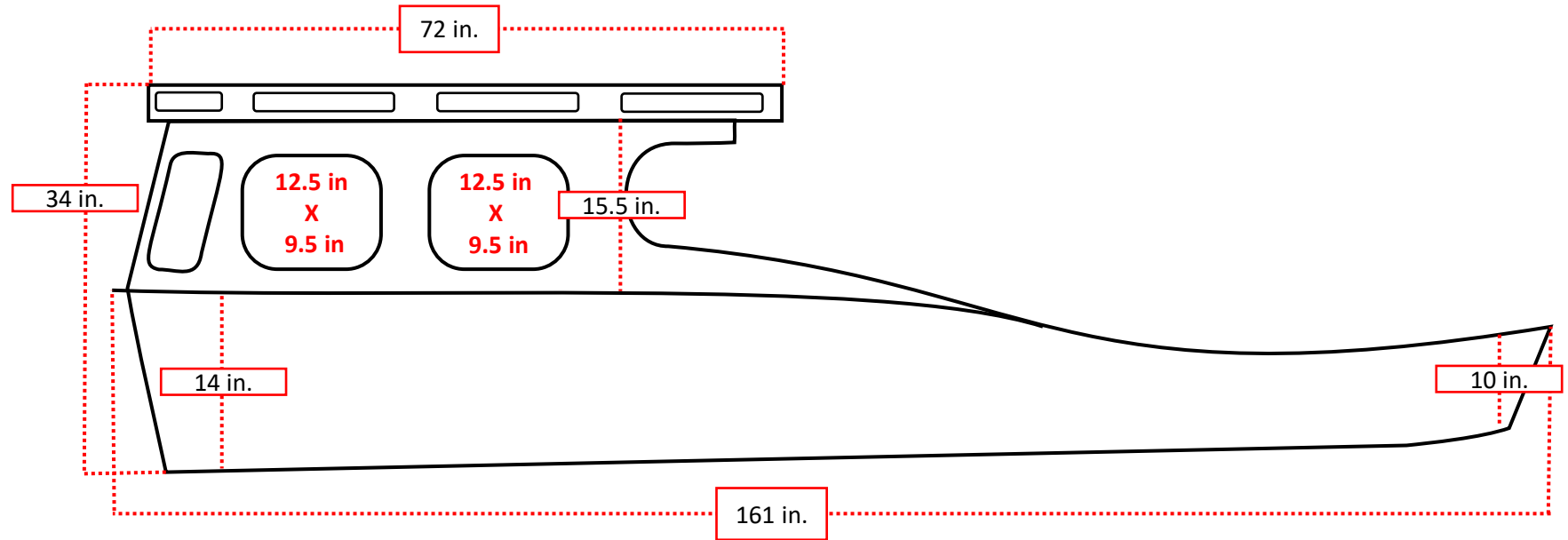
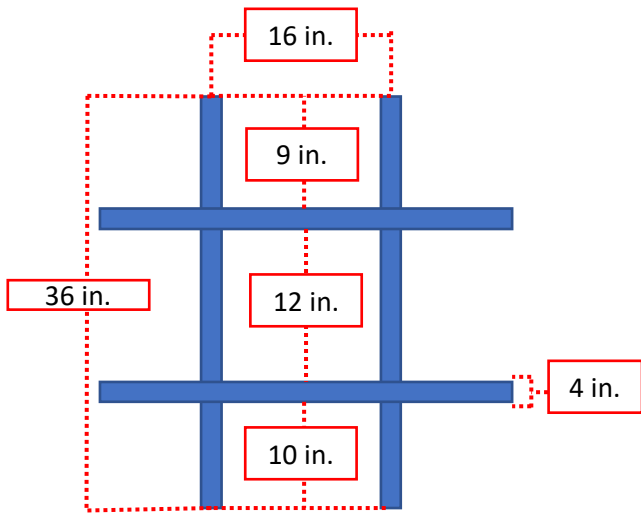

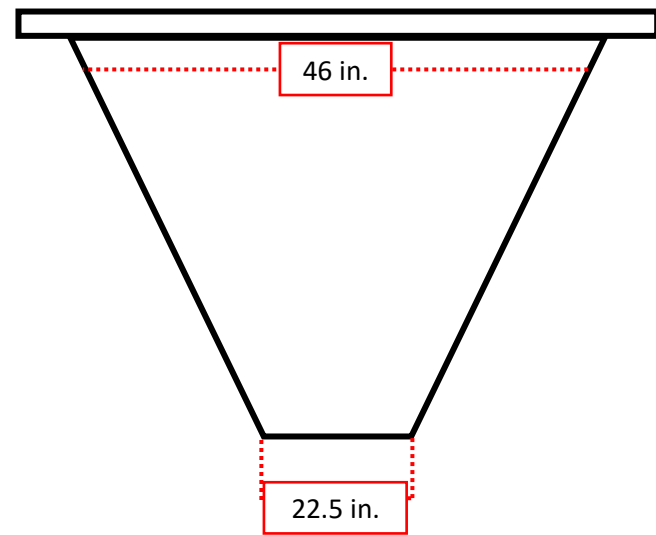
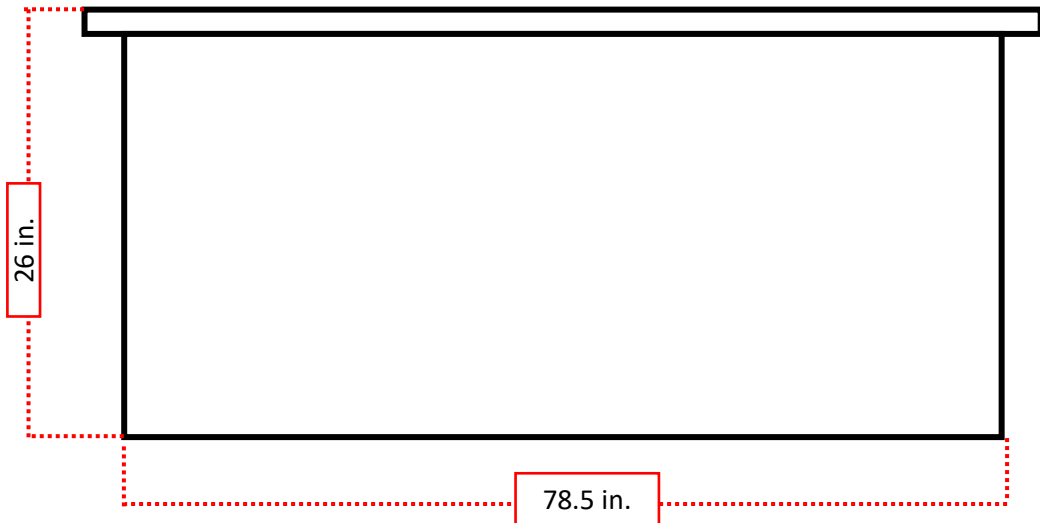
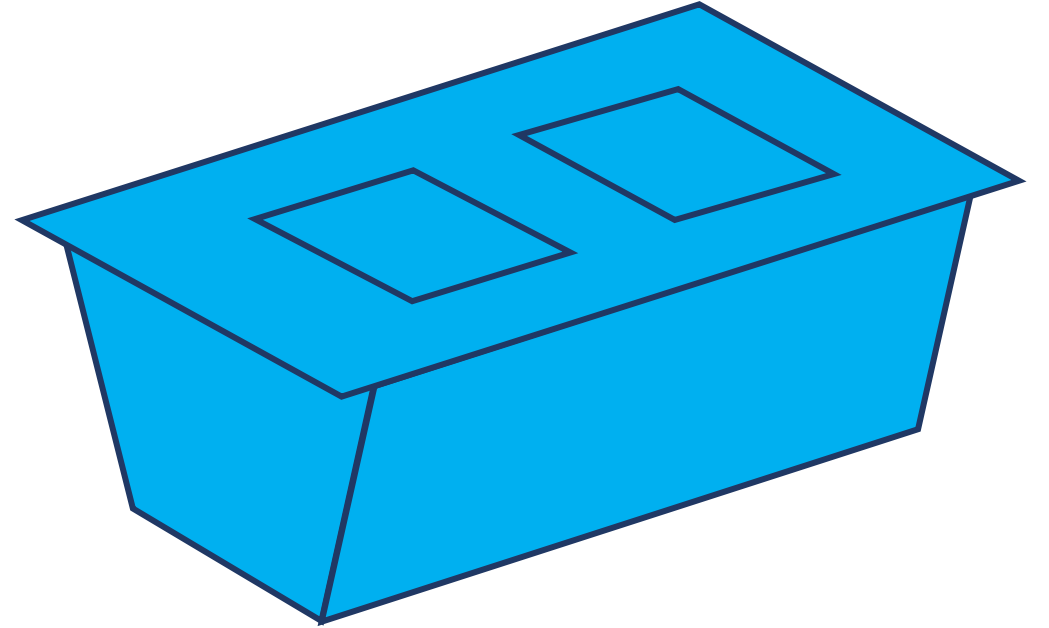
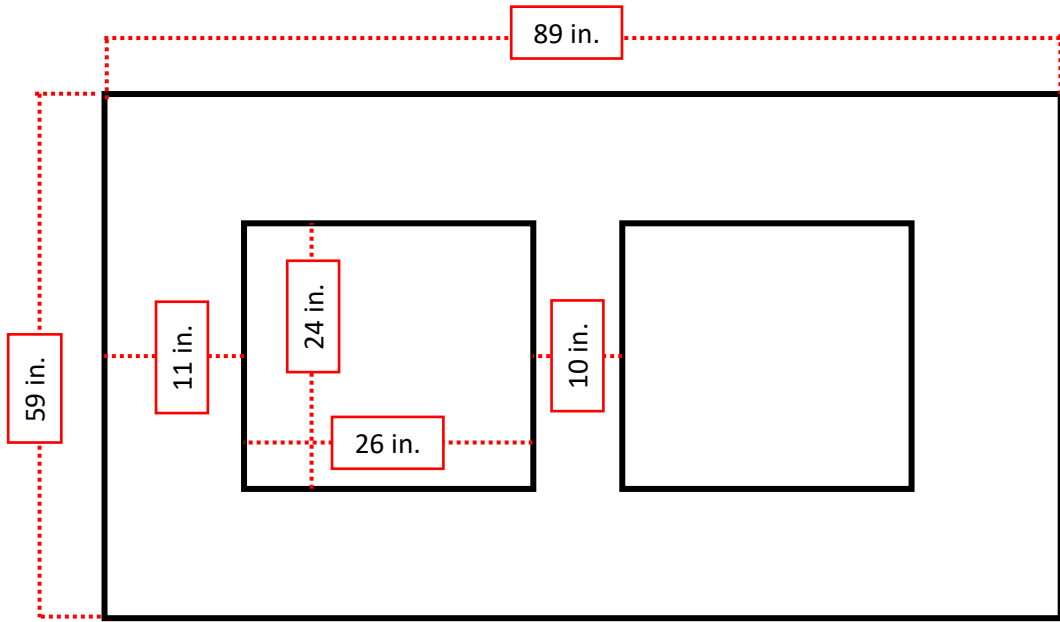

38-footer Fishing Boat

Engine

- 1 unit 4D30 or 4DR5 engine with starter including 3SM Battery

Underwater fittings

- 1 1/4" SS shafting with thread and ring nut
- 1 1/2" brass pipe,
- 24" SS propeller, 3 blade
- 1 1/4" x 1 1/2" ball joint,
- 1 1/4" SS rudder assembly,
- SS bolt and nut

15-footer Pakura

REGION I
ILOCOS SUR, ILOCOS NORTE AND PANGASINAN

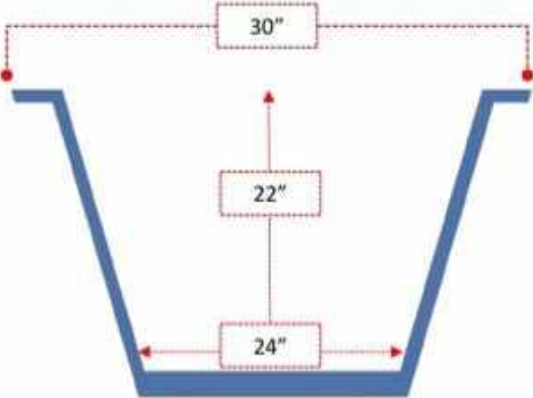
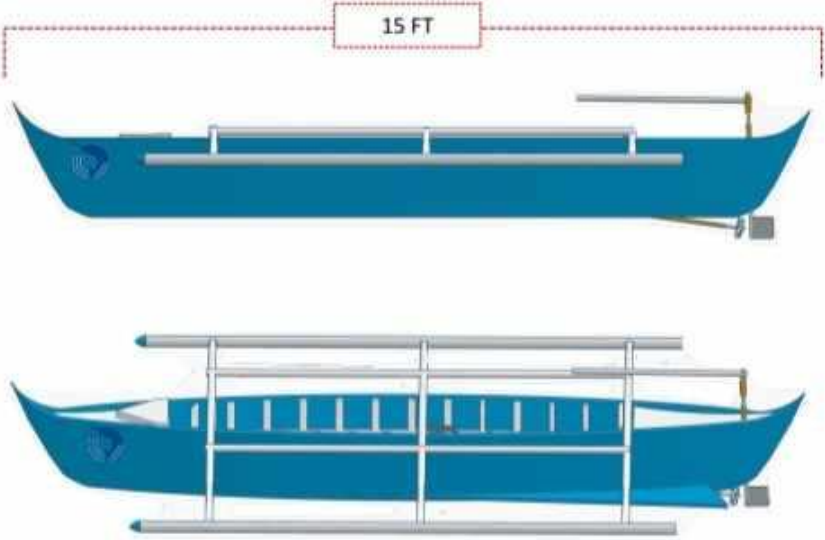

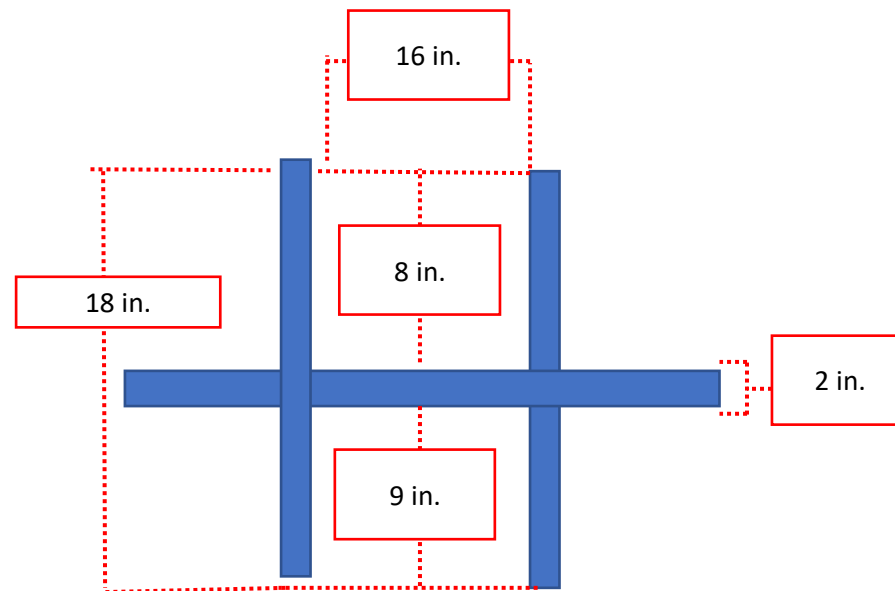
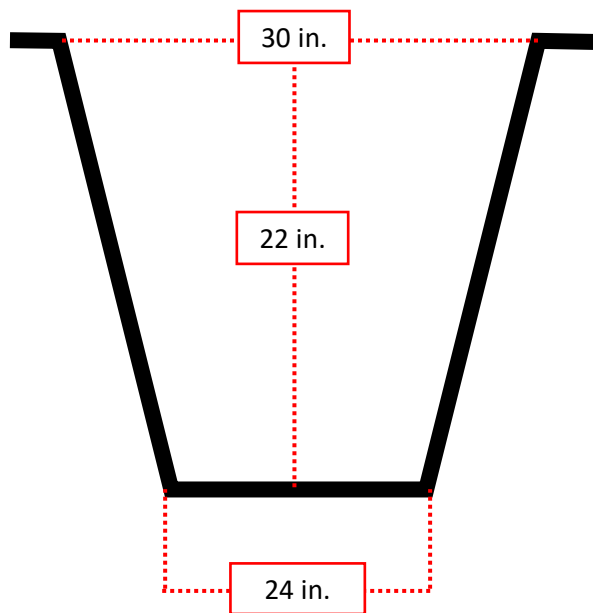
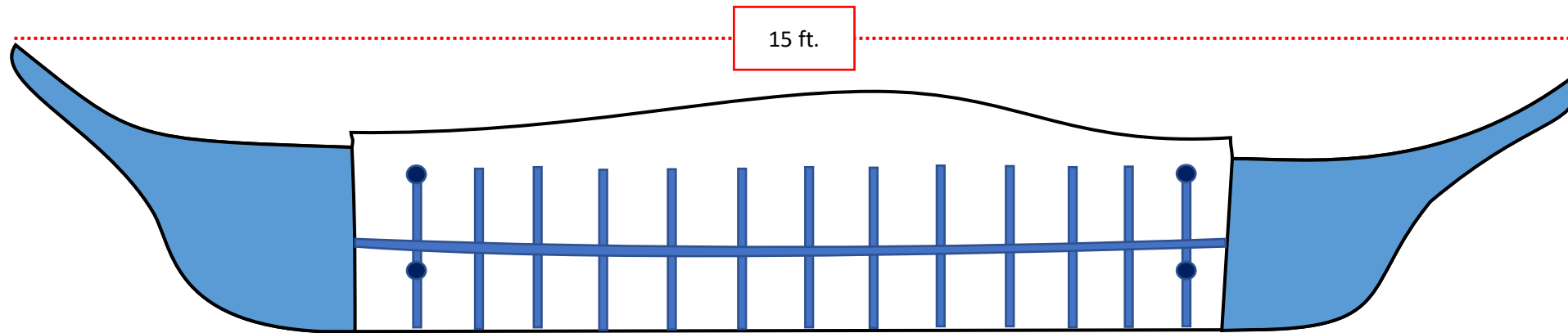

15-footer Fishing Boat

Marine gasoline engine (AMTEC Certified)

- with SS exhaust pipe

Type: 4 Stroke, OHV, Single cylinder, inclined 25°
Bore x stroke: 68.0 x 54.0 mm (2.68 x 2.13 in)
Displacement: 196 cm³ (12.0 cu-in)
Net power (SAE J1349): 5.2 kW (7.1PS) @ 4,500 rpm
Maximum net torque (SAE J1349): 13.2 N.m (1.35kgf.m)/3000 rpm
Compression Ratio: 8.1 : 1
Fuel consumption (at continuous rated power): 1.7 Liters (0.45 US gal, 0.37 Imp gal)/h
Ignition system: Transistorized magneto
Lubrication system: Forced splash
Oil capacity: 0.60 Liter (0.63 US qt, 0.53 Imp qt)
Starting system: Recoil starter
Air cleaner: Semi dry types
Fuel used: Gasoline with a pump octane rating of 86 or higher
Fuel tank capacity: 3.1 Liters (0.82 US gal, 0.68 Imp gal)
Weight: 16.0 kg (35.3 lbs)
PTO Size: 19.025 – 19.05 mm (0.7490 – 0.75 in)
Exhaust system: Stainless Steel Exhaust pipe

Underwater fittings

- 5/8" SS shafting with thread and ring nut
- 5/8" brass pipe,
- 5/8" x 9" x 1.5" SS propeller,
- 5/8" x 1" cross-joint with 2 lock bolts,
- 5/8" SS rudder assembly,
- SS bolt and nut

Outrigger (per unit)

- 1 pcs HDPE pipe, 5" diameter x 20 feet

38-footer Tuna Handliner

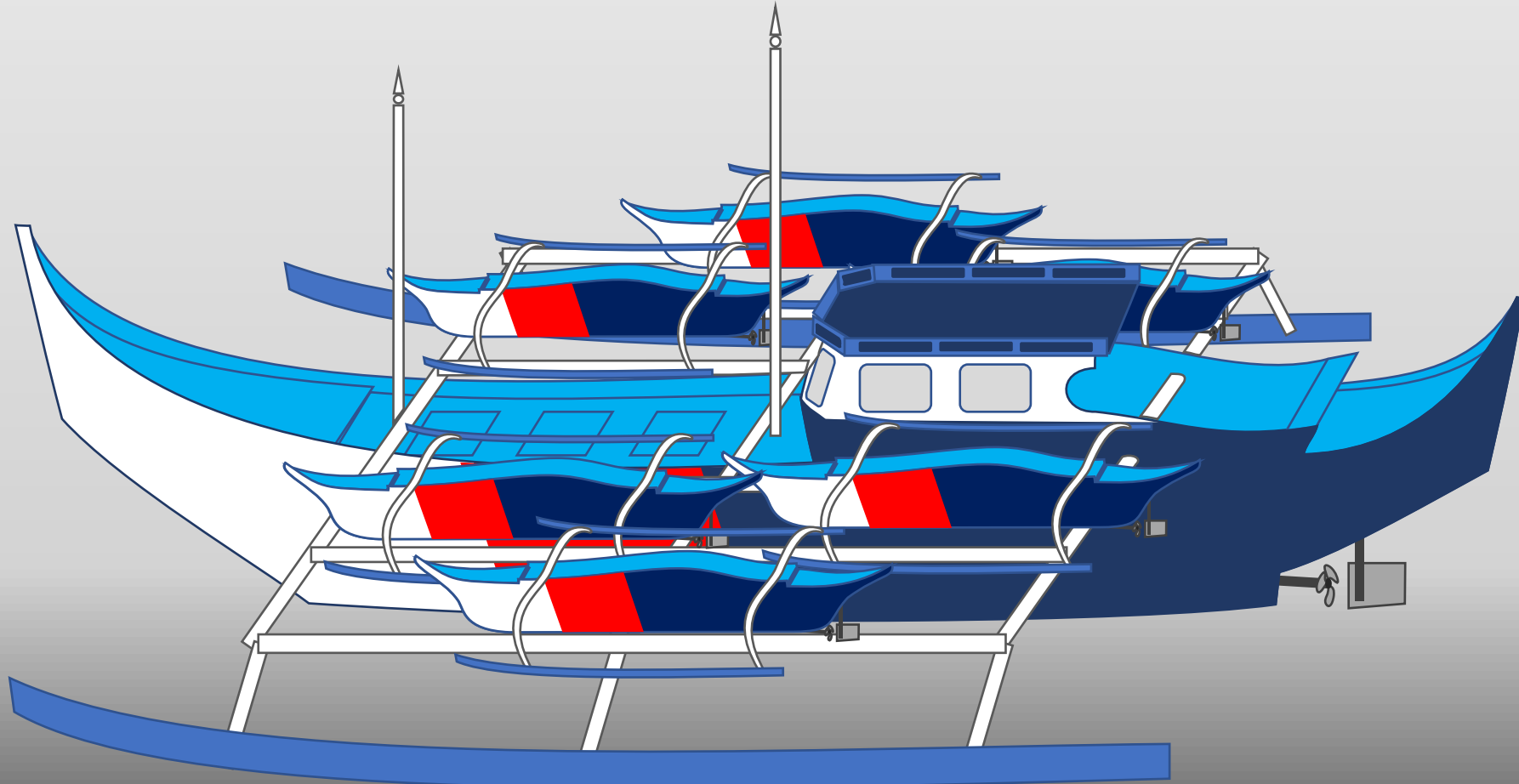

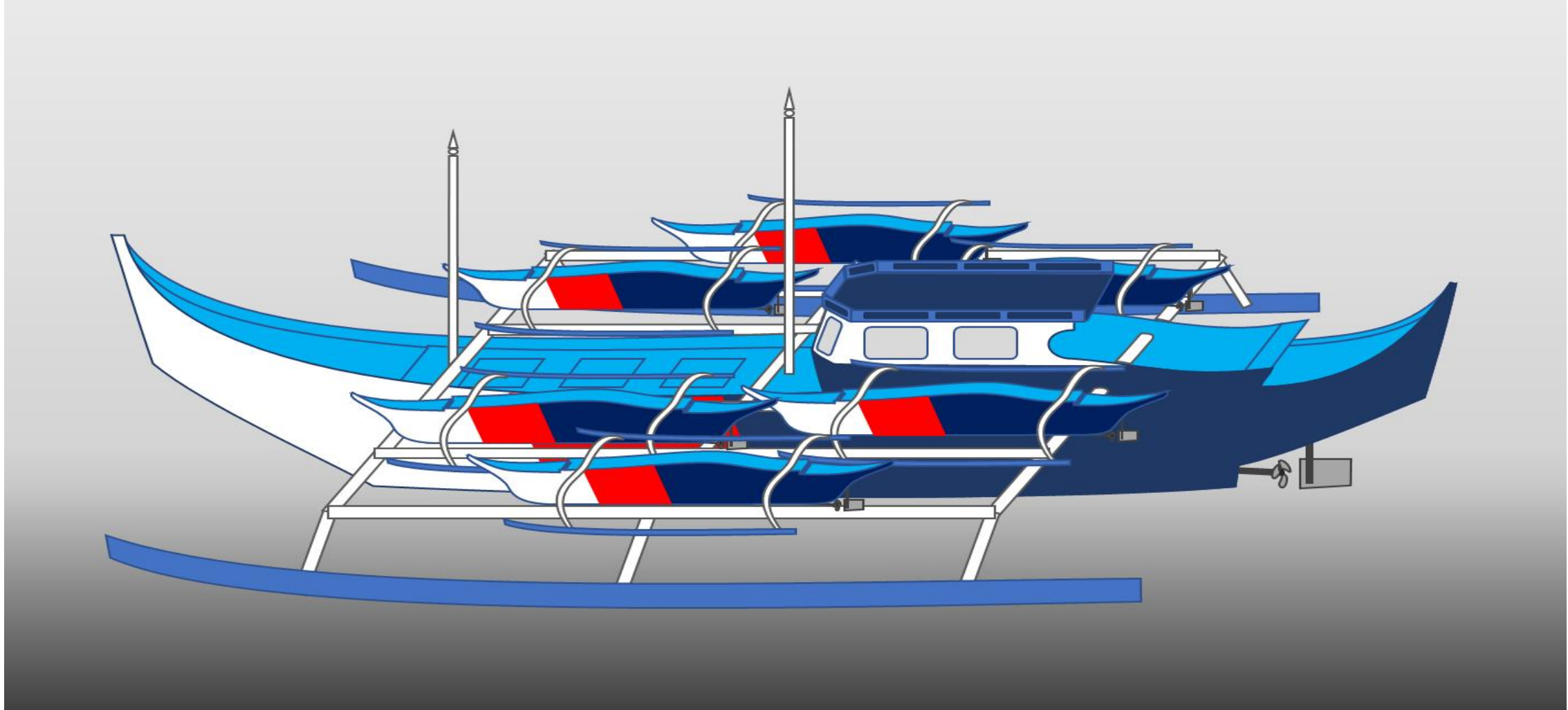

24-footer Fishing Boat



Stern



Bow

Marking

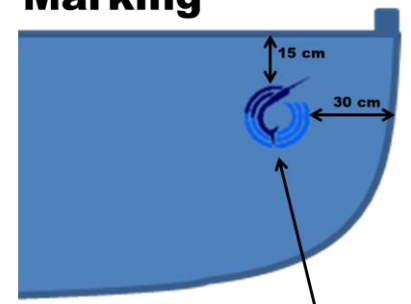

**Embossed Marking
20 cm x 20 cm**

24-footer

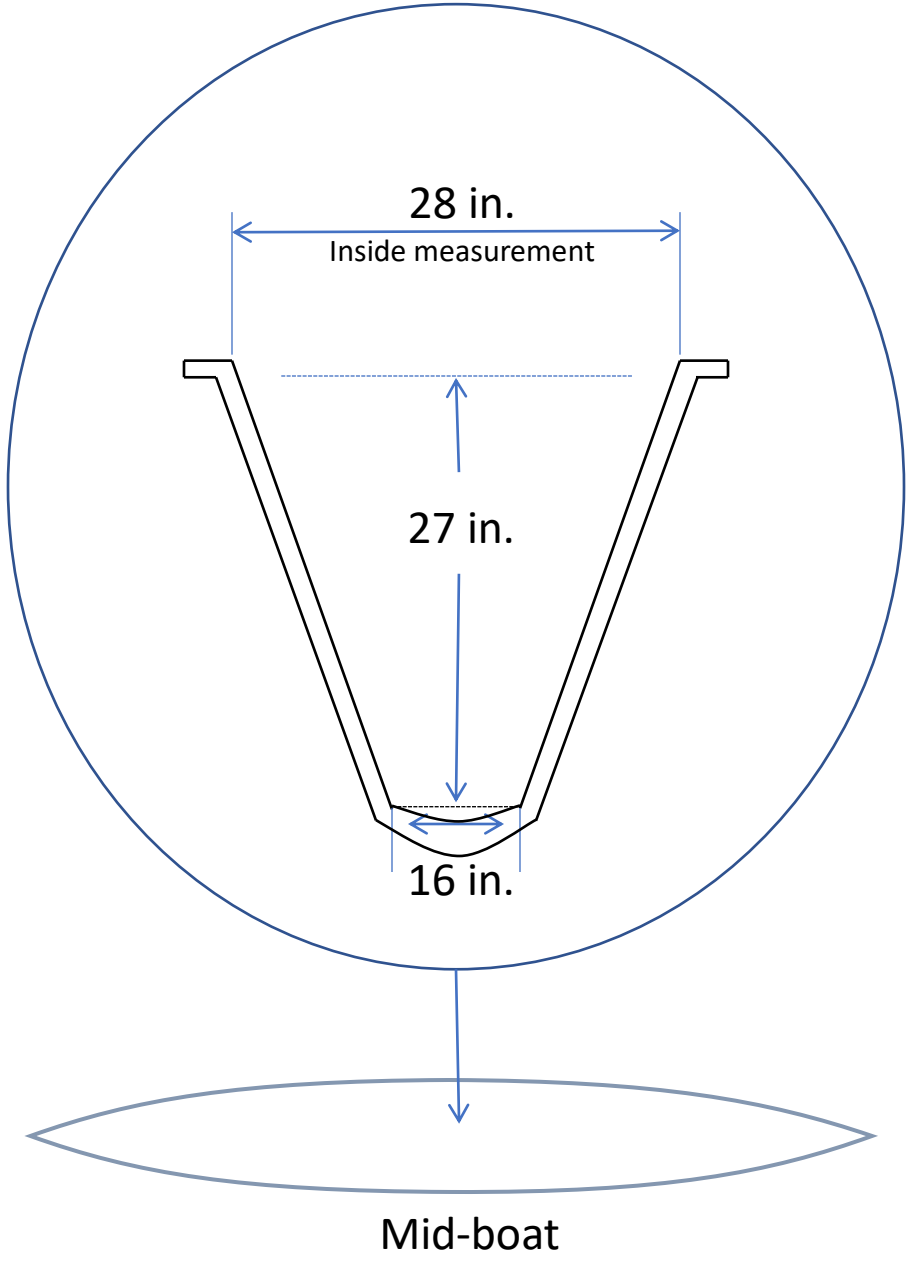

Layer Specifications:

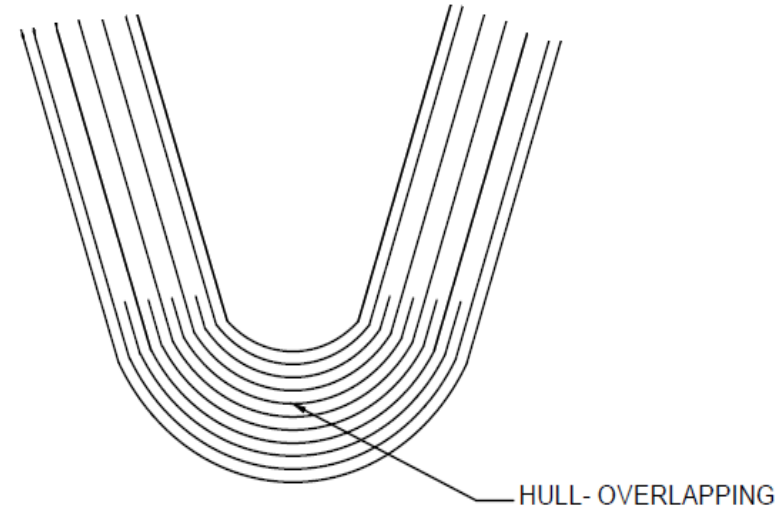
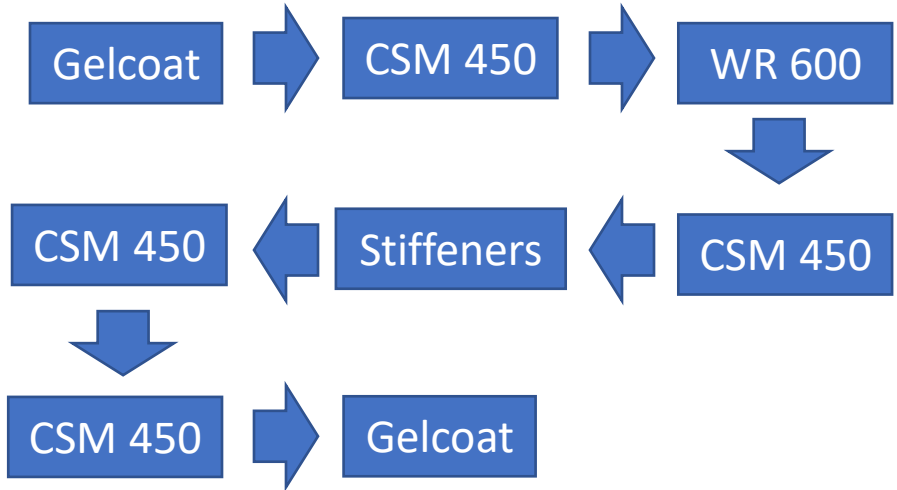

MIDSHIP SECTION LAMINATION DETAILS

Please take note of the hull.

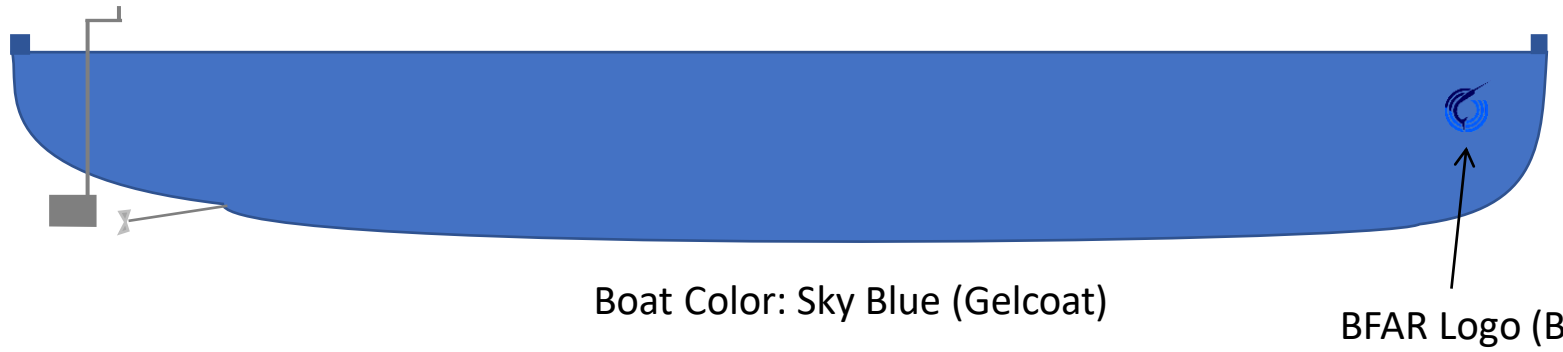
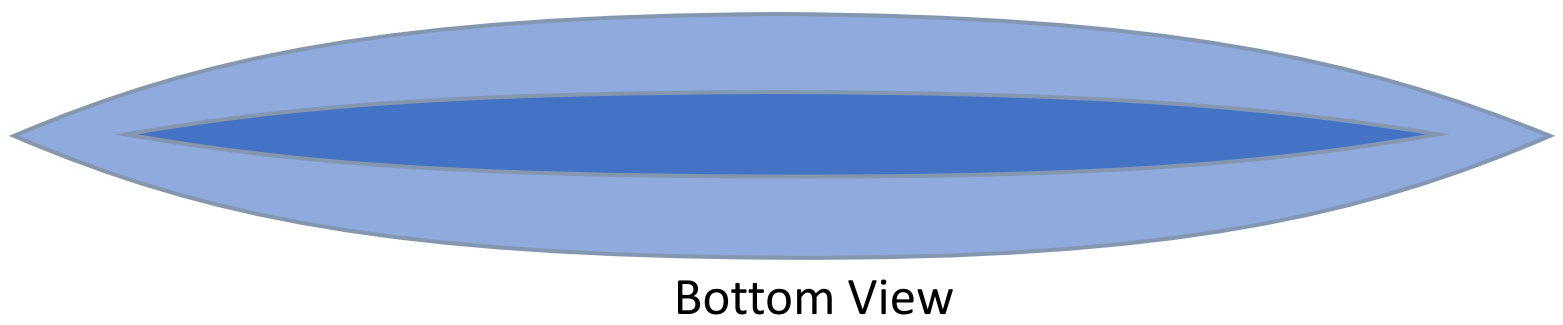
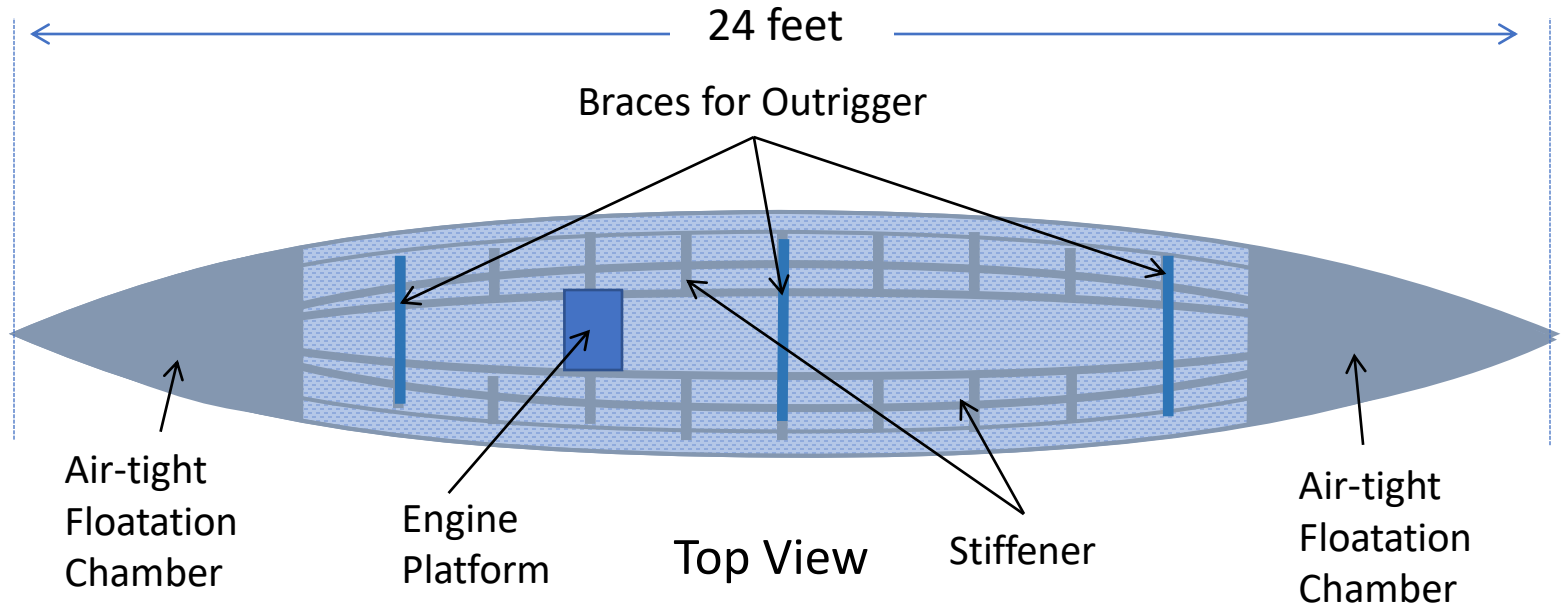

24-footer Fishing Boat

Marine gasoline engine (AMTEC Certified)

- with SS exhaust pipe

Type: 4-Stroke, OHV, single-cylinder, inclined 25°
Displacement: 389 cm³ (23.7 cu-in)
Bore x stroke: 88.0 x 64.0 mm (3.5 x 2.5 in)
Net power (SAE J1349): 11.3 kW (15.15 HP) / 4,000 rpm
Maximum RPM 5,000
Maximum Torque (Measured at PTO): 34.2 N-m / 2,500 rpm
Fuel consumption (at continuous rated power): 5.4 Liters/h
Compression Ratio: 8.2 : 1
Ignition system: Digital CDI (with Limiter)
Lubrication system: Forced splash
Oil capacity: 1.1 Liter (1.16 US qt, 0.97 Imp qt)
Starting system: Recoil starter
Air cleaner: Special air cleaner for boat (No air cleaner filter)
Reduction: 1:1.2
Dry weight: 32.4 kg
PTO diameter: 25.0 mm
Exhaust system: Stainless steel exhaust pipe

Underwater fittings

- 5/8" SS shafting with thread and ring nut
- 5/8" brass pipe,
- 5/8" x 8" x 2" SS propeller,
- 5/8" x 1" cross-joint with 2 lock bolts,
- 5/8" SS rudder assembly,
- SS bolt and nut

Outrigger material (per unit)

- 2 pcs HDPE pipe, 5" diameter x 20 feet

***Section VIII. Checklist of Technical and
Financial Documents***

Checklist of Technical and Financial Documents

I. TECHNICAL COMPONENT ENVELOPE

Class “A” Documents

Legal Documents

- (a) Valid PhilGEPS Registration Certificate (Platinum Membership) (all pages);
or
- (b) Registration certificate from Securities and Exchange Commission (SEC), Department of Trade and Industry (DTI) for sole proprietorship, or Cooperative Development Authority (CDA) for cooperatives or its equivalent document,
and
- (c) Mayor’s or Business permit issued by the city or municipality where the principal place of business of the prospective bidder is located, or the equivalent document for Exclusive Economic Zones or Areas;
and
- (d) Tax clearance per E.O. No. 398, s. 2005, as finally reviewed and approved by the Bureau of Internal Revenue (BIR).

Technical Documents

- (e) Statement of the prospective bidder of all its ongoing government and private contracts, including contracts awarded but not yet started, if any, whether similar or not similar in nature and complexity to the contract to be bid; **and**
- (f) Statement of the bidder’s Single Largest Completed Contract (SLCC) similar to the contract to be bid, except under conditions provided for in Sections 23.4.1.3 and 23.4.2.4 of the 2016 revised IRR of RA No. 9184, within the relevant period as provided in the Bidding Documents; **and**
- (g) Original copy of Bid Security. If in the form of a Surety Bond, submit also a certification issued by the Insurance Commission;
or
Original copy of Notarized Bid Securing Declaration; **and**
- (h) Conformity with the Technical Specifications, which may include production/delivery schedule, manpower requirements, and/or after-sales/parts, if applicable; **and**
- (i) Original duly signed Omnibus Sworn Statement (OSS);
and if applicable, Original Notarized Secretary’s Certificate in case of a corporation, partnership, or cooperative; or Original Special Power of Attorney of all members of the joint venture giving full power and authority to its officer to sign the OSS and do acts to represent the Bidder.

Financial Documents

- (j) The Supplier’s audited financial statements, showing, among others, the Supplier’s total and current assets and liabilities, stamped “received” by the BIR or its duly accredited and authorized institutions, for the preceding calendar year which should not be earlier than two (2) years from the date of bid submission; **and**
- (k) The prospective bidder’s computation of Net Financial Contracting

Capacity (NFCC);

or

A committed Line of Credit from a Universal or Commercial Bank in lieu of its NFCC computation.

Class "B" Documents

- (l) If applicable, a duly signed joint venture agreement (JVA) in case the joint venture is already in existence;

or

duly notarized statements from all the potential joint venture partners stating that they will enter into and abide by the provisions of the JVA in the instance that the bid is successful.

II. FINANCIAL COMPONENT ENVELOPE

- (m) Original of duly signed and accomplished Financial Bid Form; **and**

- (n) Original of duly signed and accomplished Price Schedule(s).

Other documentary requirements under RA No. 9184 (as applicable)

- (o) *[For foreign bidders claiming by reason of their country's extension of reciprocal rights to Filipinos]* Certification from the relevant government office of their country stating that Filipinos are allowed to participate in government procurement activities for the same item or product.

- (p) Certification from the DTI if the Bidder claims preference as a Domestic Bidder or Domestic Entity.

