

PHILIPPINE BIDDING DOCUMENTS

Procurement of Infrastructure Project Rehabilitation and Improvement of Seaweed Culture Laboratory for Seaweed Development Project



Bureau of Fisheries and Aquatic Resources
Regional Fisheries Office No. 1
Government Center, Sevilla, San Fernando City, La Union

TABLE OF CONTENTS

Glossary of Terms, Abbreviations, and Acronyms	4
Section I. Invitation to Bid.....	7
Section II. Instructions to Bidders	10
1. Scope of Bid	11
2. Funding Information	11
3. Bidding Requirements.....	11
4. Corrupt, Fraudulent, Collusive, Coercive, and Obstructive Practices	11
5. Eligible Bidders	12
6. Origin of Associated Goods	12
7. Subcontracts	12
8. Pre-Bid Conference.....	12
9. Clarification and Amendment of Bidding Documents	12
10. Documents Comprising the Bid: Eligibility and Technical Components.....	13
11. Documents Comprising the Bid: Financial Component	13
12. Alternative Bids.....	14
13. Bid Prices	14
14. Bid and Payment Currencies	14
15. Bid Security	14
16. Sealing and Marking of Bids.....	14
17. Deadline for Submission of Bids.....	15
18. Opening and Preliminary Examination of Bids.....	15
19. Detailed Evaluation and Comparison of Bids	15
20. Post Qualification	15
21. Signing of the Contract	16
Section III. Bid Data Sheet	17
Section IV. General Conditions of Contract.....	20
1. Scope of Contract.....	21
2. Sectional Completion of Works	21
3. Possession of Site.....	21
4. The Contractor’s Obligations	21
5. Performance Security	22
6. Site Investigation Reports	22

7.	Warranty.....	22
8.	Liability of the Contractor.....	22
9.	Termination for Other Causes	22
10.	Dayworks.....	23
11.	Program of Work.....	23
12.	Instructions, Inspections and Audits.....	23
13.	Advance Payment	23
14.	Progress Payments	23
15.	Operating and Maintenance Manuals	24
	Section V. Special Conditions of Contract.....	25
	Section VI. Specifications	27
	Section VII. Drawings.....	28
	Section VIII. Bill of Quantities	29
	Section IX. Checklist of Technical and Financial Documents	30

Glossary of Terms, Abbreviations, and Acronyms

ABC – Approved Budget for the Contract.

ARCC – Allowable Range of Contract Cost.

BAC – Bids and Awards Committee.

Bid – A signed offer or proposal to undertake a contract submitted by a bidder in response to and in consonance with the requirements of the bidding documents. Also referred to as *Proposal* and *Tender*. (2016 revised IRR, Section 5[c])

Bidder – Refers to a contractor, manufacturer, supplier, distributor and/or consultant who submits a bid in response to the requirements of the Bidding Documents. (2016 revised IRR, Section 5[d])

Bidding Documents – The documents issued by the Procuring Entity as the bases for bids, furnishing all information necessary for a prospective bidder to prepare a bid for the Goods, Infrastructure Projects, and/or Consulting Services required by the Procuring Entity. (2016 revised IRR, Section 5[e])

BIR – Bureau of Internal Revenue.

BSP – Bangko Sentral ng Pilipinas.

CDA – Cooperative Development Authority.

Consulting Services – Refer to services for Infrastructure Projects and other types of projects or activities of the GOP requiring adequate external technical and professional expertise that are beyond the capability and/or capacity of the GOP to undertake such as, but not limited to: (i) advisory and review services; (ii) pre-investment or feasibility studies; (iii) design; (iv) construction supervision; (v) management and related services; and (vi) other technical services or special studies. (2016 revised IRR, Section 5[i])

Contract – Refers to the agreement entered into between the Procuring Entity and the Supplier or Manufacturer or Distributor or Service Provider for procurement of Goods and Services; Contractor for Procurement of Infrastructure Projects; or Consultant or Consulting Firm for Procurement of Consulting Services; as the case may be, as recorded in the Contract Form signed by the parties, including all attachments and appendices thereto and all documents incorporated by reference therein.

Contractor – is a natural or juridical entity whose proposal was accepted by the Procuring Entity and to whom the Contract to execute the Work was awarded. Contractor as used in these Bidding Documents may likewise refer to a supplier, distributor, manufacturer, or consultant.

CPI – Consumer Price Index.

DOLE – Department of Labor and Employment.

DTI – Department of Trade and Industry.

Foreign-funded Procurement or Foreign-Assisted Project – Refers to procurement whose funding source is from a foreign government, foreign or international financing institution as specified in the Treaty or International or Executive Agreement. (2016 revised IRR, Section 5[b]).

GFI – Government Financial Institution.

GOCC – Government-owned and/or –controlled corporation.

Goods – Refer to all items, supplies, materials and general support services, except Consulting Services and Infrastructure Projects, which may be needed in the transaction of public businesses or in the pursuit of any government undertaking, project or activity, whether in the nature of equipment, furniture, stationery, materials for construction, or personal property of any kind, including non-personal or contractual services such as the repair and maintenance of equipment and furniture, as well as trucking, hauling, janitorial, security, and related or analogous services, as well as procurement of materials and supplies provided by the Procuring Entity for such services. The term “related” or “analogous services” shall include, but is not limited to, lease or purchase of office space, media advertisements, health maintenance services, and other services essential to the operation of the Procuring Entity. (2016 revised IRR, Section 5[r])

GOP – Government of the Philippines.

Infrastructure Projects – Include the construction, improvement, rehabilitation, demolition, repair, restoration or maintenance of roads and bridges, railways, airports, seaports, communication facilities, civil works components of information technology projects, irrigation, flood control and drainage, water supply, sanitation, sewerage and solid waste management systems, shore protection, energy/power and electrification facilities, national buildings, school buildings, hospital buildings, and other related construction projects of the government. Also referred to as *civil works or works*. (2016 revised IRR, Section 5[u])

LGUs – Local Government Units.

NFCC – Net Financial Contracting Capacity.

NGA – National Government Agency.

PCAB – Philippine Contractors Accreditation Board.

PhilGEPS - Philippine Government Electronic Procurement System.

Procurement Project – refers to a specific or identified procurement covering goods, infrastructure project or consulting services. A Procurement Project shall be described, detailed, and scheduled in the Project Procurement Management Plan prepared by the agency which shall be consolidated in the procuring entity's Annual Procurement Plan. (GPPB Circular No. 06-2019 dated 17 July 2019)

PSA – Philippine Statistics Authority.

SEC – Securities and Exchange Commission.

SLCC – Single Largest Completed Contract.

UN – United Nations.

Section I. Invitation to Bid



BAGONG PILIPINAS



DEPARTMENT OF AGRICULTURE
1996
Tagapagtaguyod ng Malinis
Masaganang Karagatan

Republic of the Philippines
DEPARTMENT OF AGRICULTURE
BUREAU OF FISHERIES AND AQUATIC RESOURCES

Regional Fisheries Office No. 1
Government Center, Sevilla, San Fernando City, La Union 2500
Telefax: (072) 242-15-59 Tel. No.: (072) 607-5115
Email: bfarfo1_records@bfar.da.gov.ph / bfarfo1_records@yahoo.com
Help Stop Illegal Fishing! Report to Bantay Dagat Hotline: SMART: 0919-996-1078

Invitation to Bid for Infrastructure Project for the Rehabilitation and Improvement of Seaweed Culture Laboratory for Seaweed Development Project

1. The *Bureau of Fisheries and Aquatic Resources-Regional Fisheries Office I (BFAR-RFO I)*, through the *General Appropriation Act of 2025 (GAA 2025)* intends to apply the sum of *Seven Million Pesos (P7,000,000.00)* being the Approved Budget for the Contract (ABC) to payments under the contract for *Improvement of Seaweed Culture Laboratory for Seaweed Development Project in Lucap, Alaminos City, Pangasinan*. Bids received in excess of the ABC shall be automatically rejected at bid opening.
2. The *BFAR-RFO I* now invites bids for the above Procurement Project. Completion of the Works is required *ninety (90) calendar days*. Bidders should have completed a contract similar to the Project. The description of an eligible bidder is contained in the Bidding Documents, particularly, in Section II (Instructions to Bidders).
3. Bidding will be conducted through open competitive bidding procedures using non-discretionary “*pass/fail*” criterion as specified in the 2016 revised Implementing Rules and Regulations (IRR) of Republic Act (RA) No. 9184.
4. Interested bidders may obtain further information from BFAR-RFO I and inspect the Bidding Documents at the address given below from *Monday to Friday, 8:00 AM to 5:00 PM*.
5. A complete set of Bidding Documents may be acquired by interested bidders on *January 22, 2025* from given address and website/s below *and upon payment of the applicable fee for the Bidding Documents, pursuant to the latest Guidelines issued by the GPPB, in the amount of Ten Thousand Pesos (P10,000.00)*. The Procuring Entity shall allow the bidder to present its proof of payment for the fees *in person, by facsimile, or through electronic means*.
6. The *BFAR-RFO I* will hold a Pre-Bid Conference on *January 30, 2025; 9:30 AM* at *BFAR RFO I, San Fernando City, La Union* and/or through videoconferencing/webcasting *via Zoomlink, which shall be open to prospective bidders*.
7. Bids must be duly received by the BAC Secretariat through manual submission at the office address as indicated below on or before *February 12, 2025; 9:00 AM*. Late bids shall not be accepted.
8. All bids must be accompanied by a bid security in any of the acceptable forms and in the amount stated in **ITB** Clause 16.

9. Bid opening shall be on February 12, 2025; 9:30 AM at the given address below *and/or* through *zoomlink*. Bids will be opened in the presence of the bidders' representatives who choose to attend the activity.
10. The *BFAR-RFO I* reserves the right to reject any and all bids, declare a failure of bidding, or not award the contract at any time prior to contract award in accordance with Sections 35.6 and 41 of the 2016 revised Implementing Rules and Regulations (IRR) of RA No. 9184, without thereby incurring any liability to the affected bidder or bidders.
11. For further information, please refer to:

Ms. Melanie D. Palencia

Head, BAC Secretariat

BFAR Regional Fisheries Office No. 1

Government Center, Sevilla, San Fernando City, La Union

Telefax No.: (072)-242-1559

Email Addresses: **bac_bfar1@yahoo.com.ph** or **bacbfar1@gmail.com**

Webpage: **<https://region1.bfar.da.gov.ph>**

12. You may visit the following websites:

For downloading of Bidding Documents: **<https://region1.bfar.da.gov.ph>**

January 22, 2025

(Signed)

ATTY. GIRLY G. DELA PEÑA

BAC Chairperson

Section II. Instructions to Bidders

1. Scope of Bid

The Procuring Entity, *Bureau of Fisheries and Aquatic Resources-Regional Fisheries Office I (BFAR-RFO I)* invites Bids for the Procurement of Infrastructure Project for the Rehabilitation and Improvement of Seaweed Culture Laboratory for Seaweed Development Project in Lucap, Alaminos City, Pangasinan, with Project Identification Number *ITB No. 2025-011*.

The Procurement Project (referred to herein as “Project”) is for the construction of Works, as described in Section VI (Specifications).

2. Funding Information

2.1. The GOP through the source of funding as indicated below for *[General Appropriation Act of 2025 (GAA 2025)]* in the amount of *Seven Million Pesos (P 7,000,000.00)*.

2.2. The source of funding is:

- a. NGA, the General Appropriations Act or Special Appropriations.

3. Bidding Requirements

The Bidding for the Project shall be governed by all the provisions of RA No. 9184 and its 2016 revised IRR, including its Generic Procurement Manual and associated policies, rules and regulations as the primary source thereof, while the herein clauses shall serve as the secondary source thereof.

Any amendments made to the IRR and other GPPB issuances shall be applicable only to the ongoing posting, advertisement, or invitation to bid by the BAC through the issuance of a supplemental or bid bulletin.

The Bidder, by the act of submitting its Bid, shall be deemed to have inspected the site, determined the general characteristics of the contracted Works and the conditions for this Project, such as the location and the nature of the work; (b) climatic conditions; (c) transportation facilities; (c) nature and condition of the terrain, geological conditions at the site communication facilities, requirements, location and availability of construction aggregates and other materials, labor, water, electric power and access roads; and (d) other factors that may affect the cost, duration and execution or implementation of the contract, project, or work and examine all instructions, forms, terms, and project requirements in the Bidding Documents.

4. Corrupt, Fraudulent, Collusive, Coercive, and Obstructive Practices

The Procuring Entity, as well as the Bidders and Contractors, shall observe the highest standard of ethics during the procurement and execution of the contract. They or through an agent shall not engage in corrupt, fraudulent, collusive, coercive, and obstructive practices defined under Annex “I” of the 2016 revised IRR of RA No. 9184 or other integrity violations in competing for the Project.

5. Eligible Bidders

- 5.1. Only Bids of Bidders found to be legally, technically, and financially capable will be evaluated.
- 5.2. The Bidder must have an experience of having completed a Single Largest Completed Contract (SLCC) that is similar to this Project, equivalent to at least fifty percent (50%) of the ABC adjusted, if necessary, by the Bidder to current prices using the PSA's CPI, except under conditions provided for in Section 23.4.2.4 of the 2016 revised IRR of RA No. 9184.

A contract is considered to be "similar" to the contract to be bid if it has the major categories of work stated in the **BDS**.
- 5.3. For Foreign-funded Procurement, the Procuring Entity and the foreign government/foreign or international financing institution may agree on another track record requirement, as specified in the Bidding Document prepared for this purpose.
- 5.4. The Bidders shall comply with the eligibility criteria under Section 23.4.2 of the 2016 IRR of RA No. 9184.

6. Origin of Associated Goods

There is no restriction on the origin of Goods other than those prohibited by a decision of the UN Security Council taken under Chapter VII of the Charter of the UN.

7. Subcontracts

- 7.1. The Bidder may subcontract portions of the Project to the extent allowed by the Procuring Entity as stated herein, but in no case more than fifty percent (50%) of the Project.

The Procuring Entity has prescribed that:

- a. Subcontracting is not allowed.

8. Pre-Bid Conference

The Procuring Entity will hold a pre-bid conference for this Project on the specified date and time and either at its physical address and/or through videoconferencing/webcasting} as indicated in paragraph 6 of the **IB**.

9. Clarification and Amendment of Bidding Documents

Prospective bidders may request for clarification on and/or interpretation of any part of the Bidding Documents. Such requests must be in writing and received by the Procuring Entity, either at its given address or through electronic mail indicated in the **IB**, at least ten (10) calendar days before the deadline set for the submission and receipt of Bids.

10. Documents Comprising the Bid: Eligibility and Technical Components

- 10.1. The first envelope shall contain the eligibility and technical documents of the Bid as specified in **Section IX. Checklist of Technical and Financial Documents**.
- 10.2. If the eligibility requirements or statements, the bids, and all other documents for submission to the BAC are in foreign language other than English, it must be accompanied by a translation in English, which shall be authenticated by the appropriate Philippine foreign service establishment, post, or the equivalent office having jurisdiction over the foreign bidder's affairs in the Philippines. For Contracting Parties to the Apostille Convention, only the translated documents shall be authenticated through an apostille pursuant to GPPB Resolution No. 13-2019 dated 23 May 2019. The English translation shall govern, for purposes of interpretation of the bid.
- 10.3. A valid special PCAB License in case of Joint Ventures, and registration for the type and cost of the contract for this Project. Any additional type of Contractor license or permit shall be indicated in the **BDS**.
- 10.4. A List of Contractor's key personnel (e.g., Project Manager, Project Engineers, Materials Engineers, and Foremen) assigned to the contract to be bid, with their complete qualification and experience data shall be provided. These key personnel must meet the required minimum years of experience set in the **BDS**.
- 10.5. A List of Contractor's major equipment units, which are owned, leased, and/or under purchase agreements, supported by proof of ownership, certification of availability of equipment from the equipment lessor/vendor for the duration of the project, as the case may be, must meet the minimum requirements for the contract set in the **BDS**.

11. Documents Comprising the Bid: Financial Component

- 11.1. The second bid envelope shall contain the financial documents for the Bid as specified in **Section IX. Checklist of Technical and Financial Documents**.
- 11.2. Any bid exceeding the ABC indicated in paragraph 1 of the **IB** shall not be accepted.
- 11.3. For Foreign-funded procurement, a ceiling may be applied to bid prices provided the conditions are met under Section 31.2 of the 2016 revised IRR of RA No. 9184.

12. Alternative Bids

Bidders shall submit offers that comply with the requirements of the Bidding Documents, including the basic technical design as indicated in the drawings and specifications. Unless there is a value engineering clause in the **BDS**, alternative Bids shall not be accepted.

13. Bid Prices

All bid prices for the given scope of work in the Project as awarded shall be considered as fixed prices, and therefore not subject to price escalation during contract implementation, except under extraordinary circumstances as determined by the NEDA and approved by the GPPB pursuant to the revised Guidelines for Contract Price Escalation guidelines.

14. Bid and Payment Currencies

14.1. Bid prices may be quoted in the local currency or tradeable currency accepted by the BSP at the discretion of the Bidder. However, for purposes of bid evaluation, Bids denominated in foreign currencies shall be converted to Philippine currency based on the exchange rate as published in the BSP reference rate bulletin on the day of the bid opening.

14.2. *Payment of the contract price shall be made in:*

- a. Philippine Pesos.

15. Bid Security

15.1. The Bidder shall submit a Bid Securing Declaration or any form of Bid Security in the amount indicated in the **BDS**, which shall be not less than the percentage of the ABC in accordance with the schedule in the **BDS**.

15.2. The Bid and bid security shall be valid until *one hundred twenty (120) calendar days*. Any bid not accompanied by an acceptable bid security shall be rejected by the Procuring Entity as non-responsive.

16. Sealing and Marking of Bids

Each Bidder shall submit one copy of the first and second components of its Bid.

The Procuring Entity may request additional hard copies and/or electronic copies of the Bid. However, failure of the Bidders to comply with the said request shall not be a ground for disqualification.

If the Procuring Entity allows the submission of bids through online submission to the given website or any other electronic means, the Bidder shall submit an electronic copy of its Bid, which must be digitally signed. An electronic copy that cannot be

opened or is corrupted shall be considered non-responsive and, thus, automatically disqualified.

17. Deadline for Submission of Bids

The Bidders shall submit on the specified date and time and either at its physical address or through online submission as indicated in paragraph 7 of the **IB**.

18. Opening and Preliminary Examination of Bids

18.1. The BAC shall open the Bids in public at the time, on the date, and at the place specified in paragraph 9 of the **IB**. The Bidders' representatives who are present shall sign a register evidencing their attendance. In case videoconferencing, webcasting or other similar technologies will be used, attendance of participants shall likewise be recorded by the BAC Secretariat.

In case the Bids cannot be opened as scheduled due to justifiable reasons, the rescheduling requirements under Section 29 of the 2016 revised IRR of RA No. 9184 shall prevail.

18.2. The preliminary examination of Bids shall be governed by Section 30 of the 2016 revised IRR of RA No. 9184.

19. Detailed Evaluation and Comparison of Bids

19.1. The Procuring Entity's BAC shall immediately conduct a detailed evaluation of all Bids rated "*passed*" using non-discretionary pass/fail criteria. The BAC shall consider the conditions in the evaluation of Bids under Section 32.2 of 2016 revised IRR of RA No. 9184.

19.2. If the Project allows partial bids, all Bids and combinations of Bids as indicated in the **BDS** shall be received by the same deadline and opened and evaluated simultaneously so as to determine the Bid or combination of Bids offering the lowest calculated cost to the Procuring Entity. Bid Security as required by **ITB** Clause 15 shall be submitted for each contract (lot) separately.

19.3. In all cases, the NFCC computation pursuant to Section 23.4.2.6 of the 2016 revised IRR of RA No. 9184 must be sufficient for the total of the ABCs for all the lots participated in by the prospective Bidder.

20. Post Qualification

Within a non-extendible period of five (5) calendar days from receipt by the Bidder of the notice from the BAC that it submitted the Lowest Calculated Bid, the Bidder shall submit its latest income and business tax returns filed and paid through the BIR Electronic Filing and Payment System (eFPS), and other appropriate licenses and permits required by law and stated in the **BDS**.

21. Signing of the Contract

The documents required in Section 37.2 of the 2016 revised IRR of RA No. 9184 shall form part of the Contract. Additional Contract documents are indicated in the **BDS**.

Section III. Bid Data Sheet

Bid Data Sheet

ITB Clause																									
5.2	For this purpose, contracts similar to the Project refer to contracts which have the same major categories of work, which shall be: <ul style="list-style-type: none"> • <i>Building construction</i> 																								
7.1	<i>Sub-contracting is not allowed</i>																								
10.3	<i>No further instructions</i>																								
10.4	<p>The key personnel must meet the required minimum years of experience set below:</p> <table border="1" style="width: 100%; border-collapse: collapse;"> <thead> <tr> <th style="text-align: center;"><u>Key Personnel</u></th> <th style="text-align: center;"><u>General Experience</u></th> <th style="text-align: center;"><u>Relevant Experience</u></th> </tr> </thead> <tbody> <tr> <td style="text-align: center;">Key Personnel</td> <td style="text-align: center;">General Experience</td> <td style="text-align: center;">Relevant Experience</td> </tr> <tr> <td>Project Manager</td> <td style="text-align: center;">1 year</td> <td style="text-align: center;">1 year</td> </tr> <tr> <td>Project Engineer</td> <td style="text-align: center;">1 year</td> <td style="text-align: center;">1 year</td> </tr> <tr> <td>Electrician</td> <td style="text-align: center;">1 year</td> <td style="text-align: center;">1 year</td> </tr> <tr> <td>Plumber</td> <td style="text-align: center;">1 year</td> <td style="text-align: center;">1 year</td> </tr> <tr> <td>Construction Foreman</td> <td style="text-align: center;">1 year</td> <td style="text-align: center;">1 year</td> </tr> <tr> <td>Safety Officer</td> <td style="text-align: center;">1 year</td> <td style="text-align: center;">1 year</td> </tr> </tbody> </table>	<u>Key Personnel</u>	<u>General Experience</u>	<u>Relevant Experience</u>	Key Personnel	General Experience	Relevant Experience	Project Manager	1 year	1 year	Project Engineer	1 year	1 year	Electrician	1 year	1 year	Plumber	1 year	1 year	Construction Foreman	1 year	1 year	Safety Officer	1 year	1 year
<u>Key Personnel</u>	<u>General Experience</u>	<u>Relevant Experience</u>																							
Key Personnel	General Experience	Relevant Experience																							
Project Manager	1 year	1 year																							
Project Engineer	1 year	1 year																							
Electrician	1 year	1 year																							
Plumber	1 year	1 year																							
Construction Foreman	1 year	1 year																							
Safety Officer	1 year	1 year																							
10.5	<p>The minimum major equipment requirements are the following:</p> <table border="1" style="width: 100%; border-collapse: collapse;"> <thead> <tr> <th style="text-align: center;"><u>Equipment</u></th> <th style="text-align: center;"><u>Capacity</u></th> <th style="text-align: center;"><u>Number of Units</u></th> </tr> </thead> <tbody> <tr> <td style="text-align: center;">Equipment</td> <td style="text-align: center;">Capacity</td> <td style="text-align: center;">Number of Units</td> </tr> <tr> <td>Concrete mixer</td> <td style="text-align: center;">2-bagger</td> <td style="text-align: center;">1</td> </tr> <tr> <td>Concrete vibrator</td> <td style="text-align: center;">3 HP</td> <td style="text-align: center;">1</td> </tr> <tr> <td>Welding machine</td> <td style="text-align: center;">240V</td> <td style="text-align: center;">1</td> </tr> <tr> <td>Water pump</td> <td style="text-align: center;">2HP</td> <td style="text-align: center;">1</td> </tr> </tbody> </table>	<u>Equipment</u>	<u>Capacity</u>	<u>Number of Units</u>	Equipment	Capacity	Number of Units	Concrete mixer	2-bagger	1	Concrete vibrator	3 HP	1	Welding machine	240V	1	Water pump	2HP	1						
<u>Equipment</u>	<u>Capacity</u>	<u>Number of Units</u>																							
Equipment	Capacity	Number of Units																							
Concrete mixer	2-bagger	1																							
Concrete vibrator	3 HP	1																							
Welding machine	240V	1																							
Water pump	2HP	1																							
12	<i>No Further Instruction</i>																								
15.1	<p>The bid security shall be in the form of a Bid Securing Declaration or any of the following forms and amounts:</p> <ol style="list-style-type: none"> a. The amount of not less than <i>One Hundred Forty Thousand Pesos (P140,000.00)</i>, if bid security is in cash, cashier's/manager's check, bank draft/guarantee or irrevocable letter of credit; b. The amount of not less than <i>Three Hundred Fifty Thousand Pesos (350,000.00)</i>, if bid security is in Surety Bond. 																								
19.2	Partial bids are NOT allowed																								
20	<i>No Further Instruction</i>																								

21	Additional contract documents relevant to the Project that may be required by existing laws and/or the Procuring Entity, such as construction schedule and S-curve, manpower schedule, construction methods, equipment utilization schedule, construction safety and health program approved by the DOLE, and other acceptable tools of project scheduling.
----	---

Section IV. General Conditions of Contract

1. **Scope of Contract**

This Contract shall include all such items, although not specifically mentioned, that can be reasonably inferred as being required for its completion as if such items were expressly mentioned herein. All the provisions of RA No. 9184 and its 2016 revised IRR, including the Generic Procurement Manual, and associated issuances, constitute the primary source for the terms and conditions of the Contract, and thus, applicable in contract implementation. Herein clauses shall serve as the secondary source for the terms and conditions of the Contract.

This is without prejudice to Sections 74.1 and 74.2 of the 2016 revised IRR of RA No. 9184 allowing the GPPB to amend the IRR, which shall be applied to all procurement activities, the advertisement, posting, or invitation of which were issued after the effectivity of the said amendment.

2. **Sectional Completion of Works**

If sectional completion is specified in the **Special Conditions of Contract (SCC)**, references in the Conditions of Contract to the Works, the Completion Date, and the Intended Completion Date shall apply to any Section of the Works (other than references to the Completion Date and Intended Completion Date for the whole of the Works).

3. **Possession of Site**

3.1 The Procuring Entity shall give possession of all or parts of the Site to the Contractor based on the schedule of delivery indicated in the **SCC**, which corresponds to the execution of the Works. If the Contractor suffers delay or incurs cost from failure on the part of the Procuring Entity to give possession in accordance with the terms of this clause, the Procuring Entity's Representative shall give the Contractor a Contract Time Extension and certify such sum as fair to cover the cost incurred, which sum shall be paid by Procuring Entity.

3.2 If possession of a portion is not given by the above date, the Procuring Entity will be deemed to have delayed the start of the relevant activities. The resulting adjustments in contract time to address such delay may be addressed through contract extension provided under Annex "E" of the 2016 revised IRR of RA No. 9184.

4. **The Contractor's Obligations**

The Contractor shall employ the key personnel named in the Schedule of Key Personnel indicating their designation, in accordance with **ITB** Clause 10.3 and specified in the **BDS**, to carry out the supervision of the Works.

The Procuring Entity will approve any proposed replacement of key personnel only if their relevant qualifications and abilities are equal to or better than those of the personnel listed in the Schedule.

5. Performance Security

- 5.1. Within ten (10) calendar days from receipt of the Notice of Award from the Procuring Entity but in no case later than the signing of the contract by both parties, the successful Bidder shall furnish the performance security in any of the forms prescribed in Section 39 of the 2016 revised IRR.
- 5.2. The Contractor, by entering into the Contract with the Procuring Entity, acknowledges the right of the Procuring Entity to institute action pursuant to RA No. 3688 against any subcontractor be they an individual, firm, partnership, corporation, or association supplying the Contractor with labor, materials and/or equipment for the performance of this Contract.

6. Site Investigation Reports

The Contractor, in preparing the Bid, shall rely on any Site Investigation Reports referred to in the **SCC** supplemented by any information obtained by the Contractor.

7. Warranty

- 7.1. In case the Contractor fails to undertake the repair works under Section 62.2.2 of the 2016 revised IRR, the Procuring Entity shall forfeit its performance security, subject its property(ies) to attachment or garnishment proceedings, and perpetually disqualify it from participating in any public bidding. All payables of the GOP in his favor shall be offset to recover the costs.
- 7.2. The warranty against Structural Defects/Failures, except that occasioned-on force majeure, shall cover the period from the date of issuance of the Certificate of Final Acceptance by the Procuring Entity. Specific duration of the warranty is found in the **SCC**.

8. Liability of the Contractor

Subject to additional provisions, if any, set forth in the **SCC**, the Contractor's liability under this Contract shall be as provided by the laws of the Republic of the Philippines.

If the Contractor is a joint venture, all partners to the joint venture shall be jointly and severally liable to the Procuring Entity.

9. Termination for Other Causes

Contract termination shall be initiated in case it is determined *prima facie* by the Procuring Entity that the Contractor has engaged, before, or during the implementation of the contract, in unlawful deeds and behaviors relative to contract acquisition and implementation, such as, but not limited to corrupt, fraudulent, collusive, coercive, and obstructive practices as stated in **ITB** Clause 4.

10. Dayworks

Subject to the guidelines on Variation Order in Annex “E” of the 2016 revised IRR of RA No. 9184, and if applicable as indicated in the **SCC**, the Dayworks rates in the Contractor’s Bid shall be used for small additional amounts of work only when the Procuring Entity’s Representative has given written instructions in advance for additional work to be paid for in that way.

11. Program of Work

11.1. The Contractor shall submit to the Procuring Entity’s Representative for approval the said Program of Work showing the general methods, arrangements, order, and timing for all the activities in the Works. The submissions of the Program of Work are indicated in the **SCC**.

11.2. The Contractor shall submit to the Procuring Entity’s Representative for approval an updated Program of Work at intervals no longer than the period stated in the **SCC**. If the Contractor does not submit an updated Program of Work within this period, the Procuring Entity’s Representative may withhold the amount stated in the **SCC** from the next payment certificate and continue to withhold this amount until the next payment after the date on which the overdue Program of Work has been submitted.

12. Instructions, Inspections and Audits

The Contractor shall permit the GOP or the Procuring Entity to inspect the Contractor’s accounts and records relating to the performance of the Contractor and to have them audited by auditors of the GOP or the Procuring Entity, as may be required.

13. Advance Payment

The Procuring Entity shall, upon a written request of the Contractor which shall be submitted as a Contract document, make an advance payment to the Contractor in an amount not exceeding fifteen percent (15%) of the total contract price, to be made in lump sum, or at the most two installments according to a schedule specified in the **SCC**, subject to the requirements in Annex “E” of the 2016 revised IRR of RA No. 9184.

14. Progress Payments

The Contractor may submit a request for payment for Work accomplished. Such requests for payment shall be verified and certified by the Procuring Entity’s Representative/Project Engineer. Except as otherwise stipulated in the **SCC**, materials and equipment delivered on the site but not completely put in place shall not be included for payment.

15. Operating and Maintenance Manuals

- 15.1. If required, the Contractor will provide “as built” Drawings and/or operating and maintenance manuals as specified in the **SCC**.
- 15.2. If the Contractor does not provide the Drawings and/or manuals by the dates stated above, or they do not receive the Procuring Entity’s Representative’s approval, the Procuring Entity’s Representative may withhold the amount stated in the **SCC** from payments due to the Contractor.

Section V. Special Conditions of Contract

Special Conditions of Contract

GCC Clause	
2	<i>The intended Completion Date is ninety (90) calendar days upon receipt of Notice to Proceed</i>
4.1	<i>The Procuring Entity shall give possession of the site to the Contractor upon receipt of the Notice to Proceed.</i>
6	The site investigation reports are: <i>None</i>
7.2	Fifteen (15) years.
10	a. Dayworks are applicable at the rate shown in the Contractor's original Bid.
11.1	The Contractor shall submit the Program of Work to the Procuring Entity's Representative within <i>seven (7)</i> days of delivery of the Notice of Award.
11.2	The amount to be withheld for late submission of an updated Program of Work is 10% of the payment due on a specified period.
13	The amount of the advance payment is <i>fifteen percent ((15%) of the total contract price and schedule of payment.</i>
14	Materials and equipment delivered on the site but not completely put in place shall be included for payment.
15.1	The date by which operating and maintenance manuals are required is <i>within 15 days prior to end of contract period.</i> The date by which "as built" drawings are required is <i>15 days from completion.</i>
15.2	The amount to be withheld for failing to produce "as built" drawings and/or operating and maintenance manuals by the date required is <i>10% of contract amount due.</i>

Section VI. Specifications

Section VII. Drawings



A PERSPECTIVE
NOT INTO SCALE



**THIS
SITE**

A VICINITY MAP
NOT INTO SCALE

1		13	
APPROVED BY:	ROSA RIO SEGUNDINA P. GAERLAN REGIONAL DIRECTOR	RECOMMENDING APPROVAL:	SANGHO V. BILOG REGIONAL SEAWEEDS FOCAL
PROJECT TITLE:	IMPROVEMENT OF SEAWEED CULTURE LABORATORY	PREPARED BY:	ENGR. GIL D. DE LEON JR. RESIDENT ENGINEER

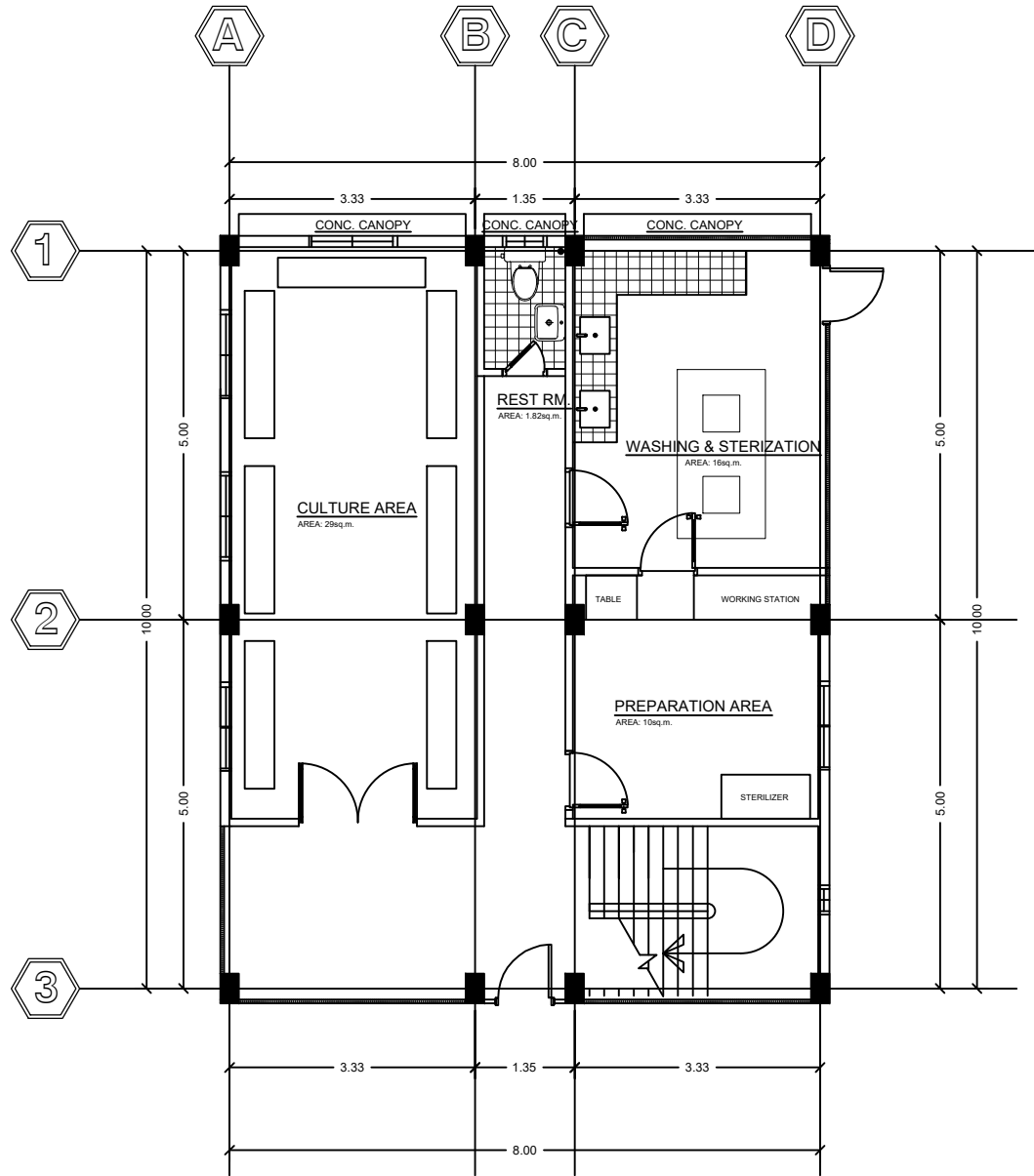

A
17
GROUND FLOOR PLAN
 SCALE 1:100 mts

2	9
APPROVED BY:	ROSARIO SEGUNDINA P. GAERLAN REGIONAL DIRECTOR
RECOMMENDING APPROVAL:	SANGHO V. BILOG REGIONAL SEaweEDS FOCAL
PROJECT TITLE:	IMPROVEMENT OF SEaweED CULTURE LABORATORY
PREPARED BY:	ENGR. GIL D. DE LEON JR. RESIDENT ENGINEER
	

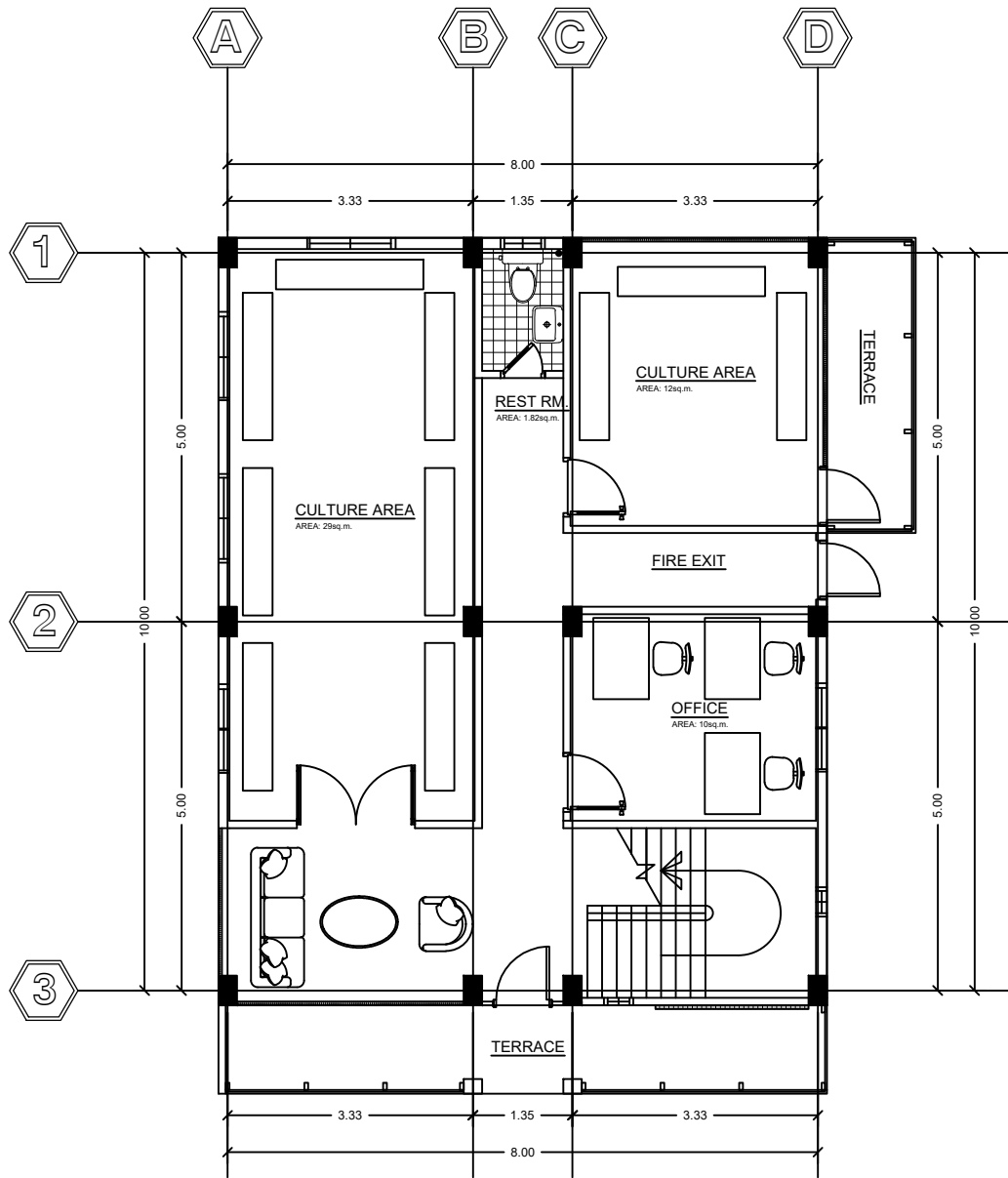

A 2ND FLOOR PLAN
 2/7 SCALE 1:100 mts

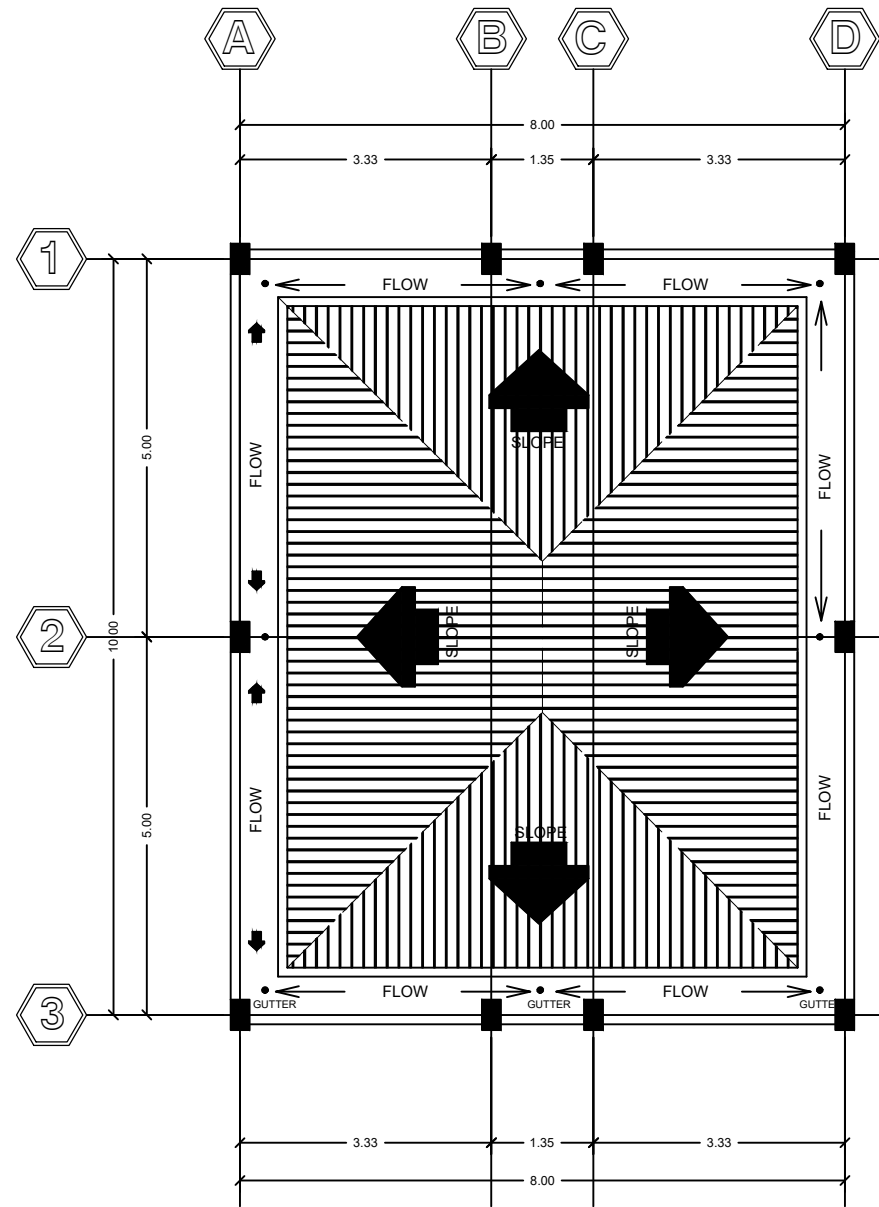

A ROOF PLAN
 3/7 SCALE 1:100 mts

3	9
	APPROVED BY: ROSARIO SEGUNDINA P. GAERLAN REGIONAL DIRECTOR
	RECOMMENDING APPROVAL: SANGHO V. BILOG REGIONAL SEAWEEDS FOCAL
PROJECT TITLE: IMPROVEMENT OF SEAWEED CULTURE LABORATORY	
PREPARED BY: ENGR. GIL D. DE LEON JR. RESIDENT ENGINEER	

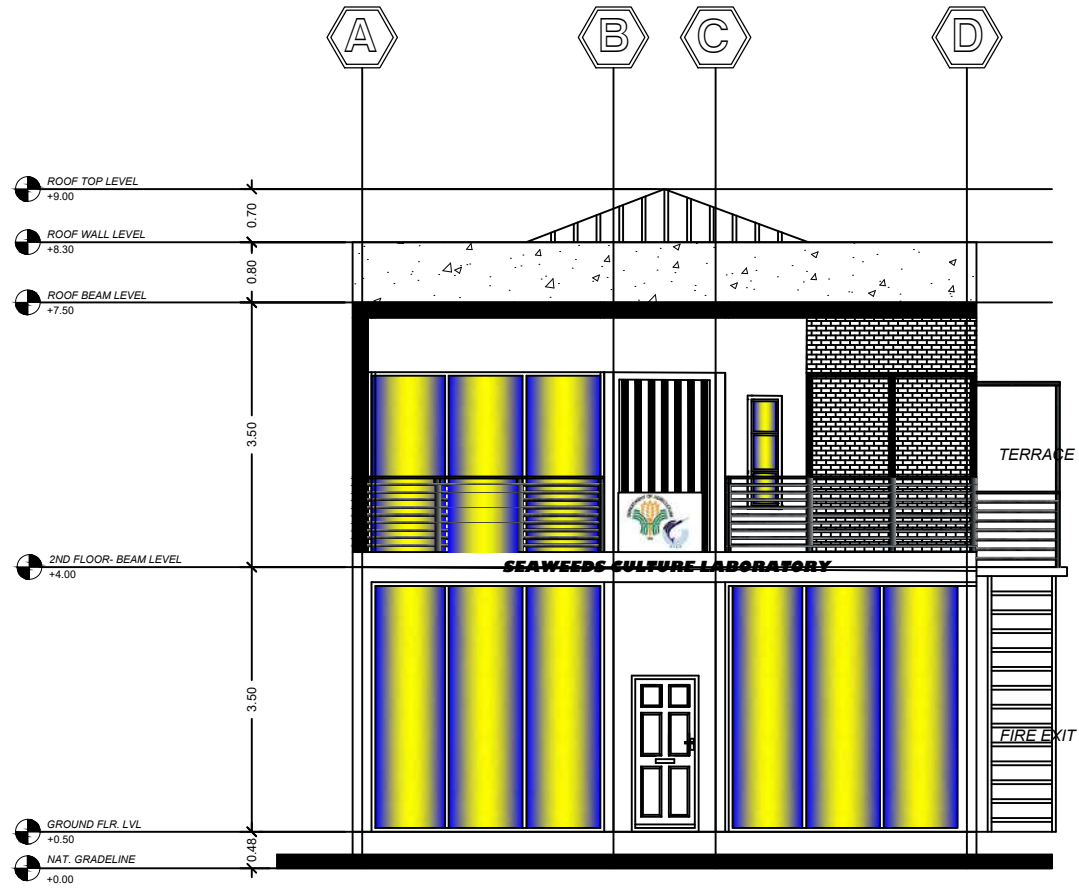

A
47 FRONT ELEVATION
SCALE 1:100 mts

APPROVED BY:	ROSARIO SEGUNDINA P. GAERLAN REGIONAL DIRECTOR
RECOMMENDING APPROVAL:	SANGHO V. BILOG REGIONAL SEaweeds FOCAL
PROJECT TITLE:	IMPROVEMENT OF SEaweeds CULTURE LABORATORY
PREPARED BY:	ENGR. GIL D. DE LEON JR. RESIDENT ENGINEER



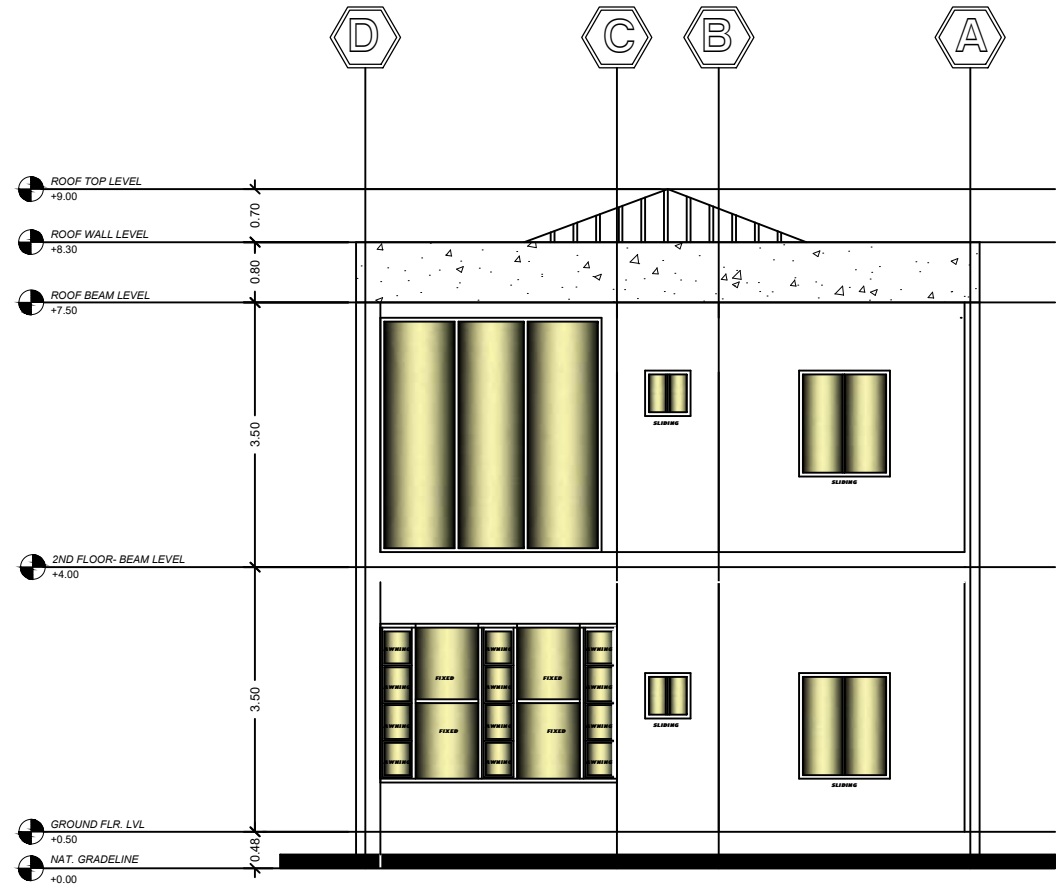

A REAR ELEVATION
 5/7 SCALE 1:100 mts

APPROVED BY:
 ROSARIO SEGUNDINA P. GAERLAN
 REGIONAL DIRECTOR

RECOMMENDING APPROVAL:
 SANGHO V. BILOG
 REGIONAL SEAWEEDES FOCAL

PROJECT TITLE:
 IMPROVEMENT OF SEAWEEED
 CULTURE LABORATORY

PREPARED BY:
 ENGR. GIL D. DE LEON JR.
 RESIDENT ENGINEER



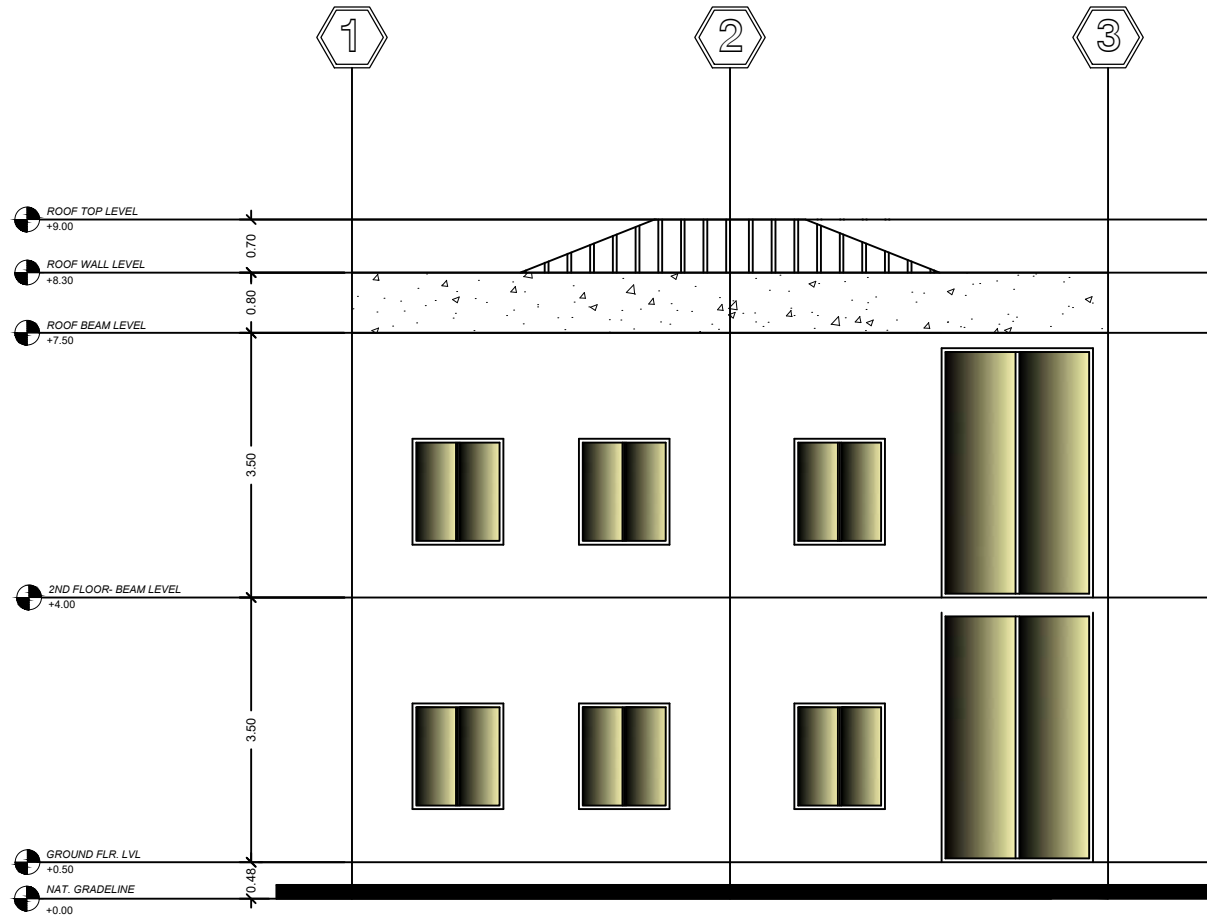

A
67
LEFT-SIDE ELEVATION
 SCALE 1:100 mts

APPROVED BY:	ROSARIO SEGUNDINA P. GAERLAN REGIONAL DIRECTOR
RECOMMENDING APPROVAL:	SANGHO V. BILOG REGIONAL SEAWEEDS FOCAL
PROJECT TITLE:	IMPROVEMENT OF SEAWEED CULTURE LABORATORY
PREPARED BY:	ENGR. GIL D. DE LEON JR. RESIDENT ENGINEER



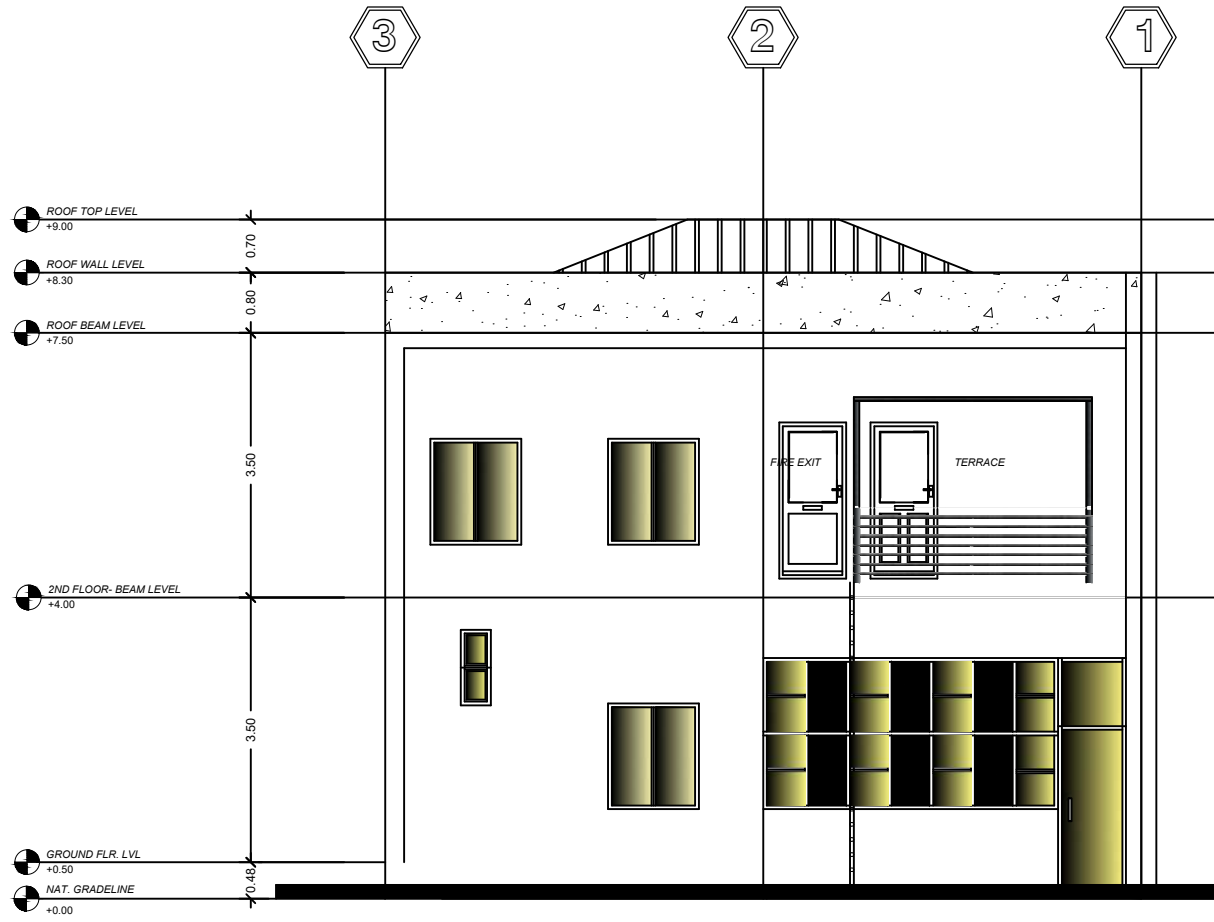

A RIGHT-SIDE ELEVATION
 7/7 SCALE 1:100 mts

APPROVED BY:

ROSARIO SEGUNDINA P. GAERLAN
 REGIONAL DIRECTOR

RECOMMENDING APPROVAL:

SANGHO V. BILOG
 REGIONAL SEAWEEDS FOCAL

PROJECT TITLE:

IMPROVEMENT OF SEAWEED
 CULTURE LABORATORY

PREPARED BY:

ENGR. GIL D. DE LEON JR.
 RESIDENT ENGINEER



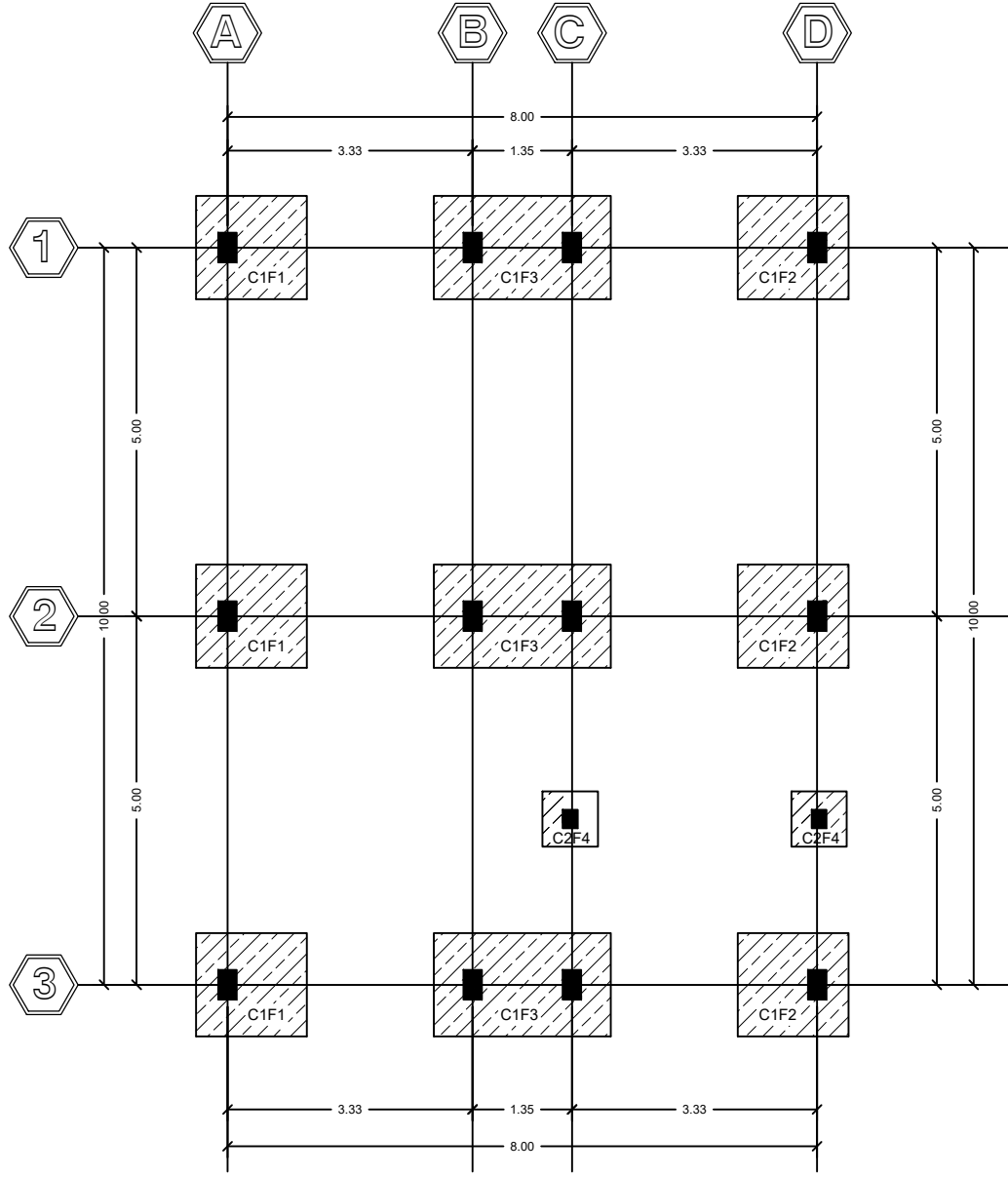

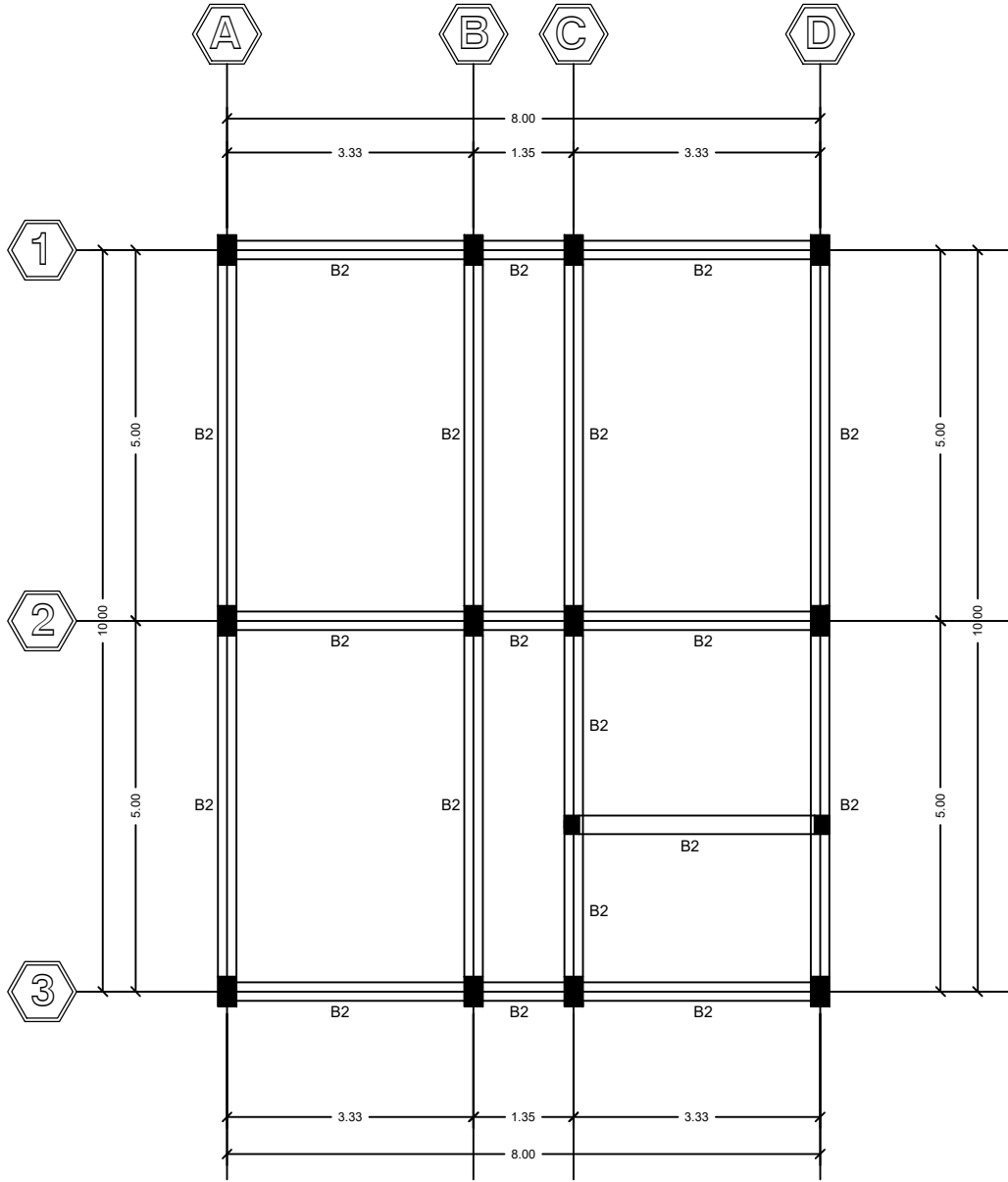

FOUNDATION PLAN
 SCALE 1:100 mts

<p>8</p> <p style="text-align: right; font-size: 24px; font-weight: bold;">13</p>
<p>APPROVED BY:</p> <p style="text-align: right; font-size: 10px;">ROSARIO SEGUNDINA P. GAERLAN REGIONAL DIRECTOR</p>
<p>RECOMMENDING APPROVAL:</p> <p style="text-align: right; font-size: 10px;">SANGHO V. BILOG REGIONAL SEAWEEDS FOCAL</p>
<p>PROJECT TITLE:</p> <p style="text-align: right; font-size: 10px;">IMPROVEMENT OF SEAWEED CULTURE LABORATORY</p>
<p>PREPARED BY:</p> <p style="text-align: right; font-size: 10px;">ENGR. GIL D. DE LEON JR. RESIDENT ENGINEER</p>
 <p style="font-size: 8px;">DEPARTMENT OF AGRICULTURE</p>



BEAM-2 LAYOUT
 SCALE 1:100 mts

PREPARED BY:	ENGR. GIL D. DE LEON JR. RESIDENT ENGINEER	PROJECT TITLE:	IMPROVEMENT OF SEAWEED CULTURE LABORATORY
RECOMMENDING APPROVAL:	SANGHO V. BILOG REGIONAL SEAWEEDS FOCAL	APPROVED BY:	ROSARIO SEGUNDINA P. GAERLAN REGIONAL DIRECTOR



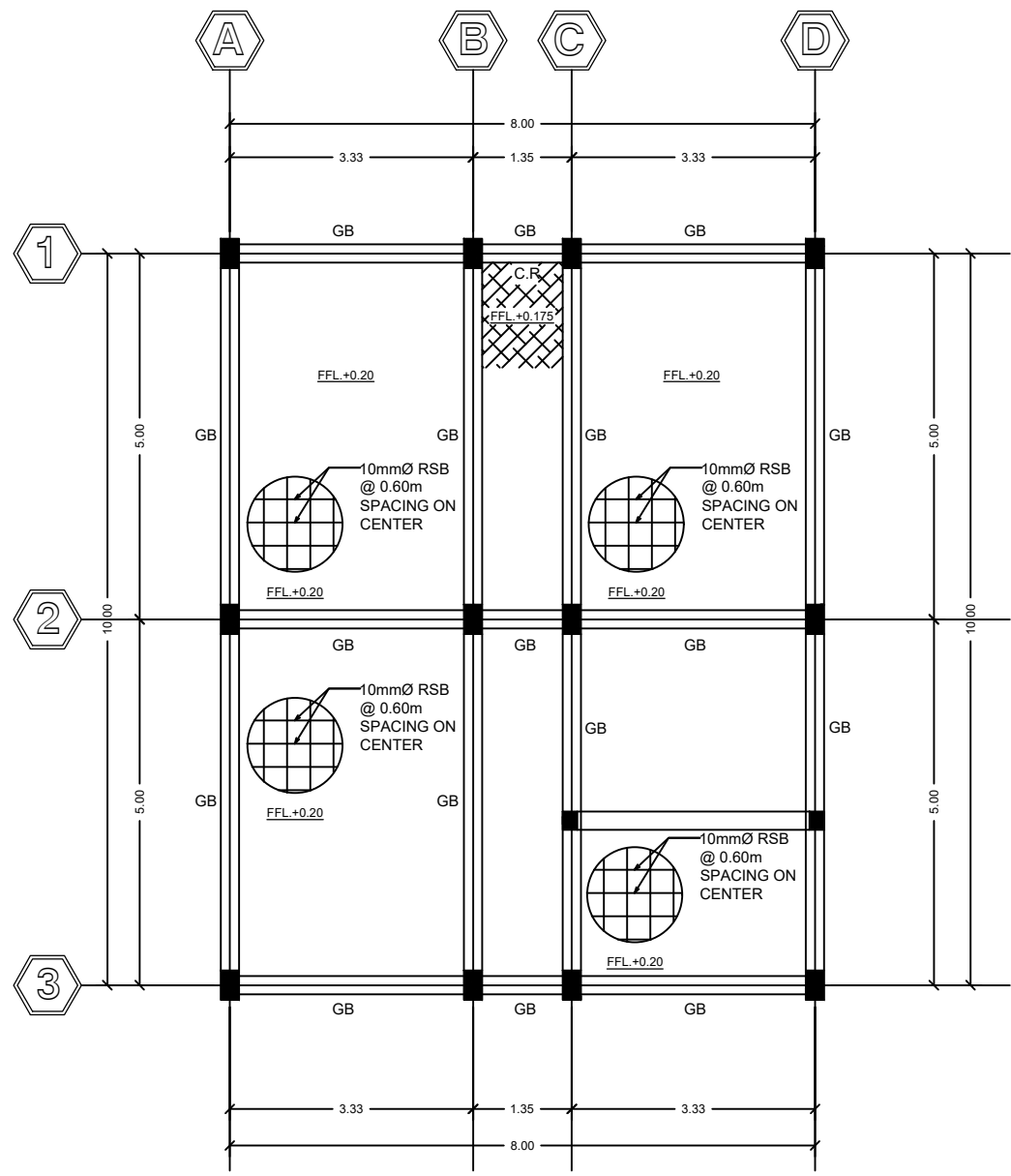

S
3/6
GRADE BEAM LAYOUT
 SCALE 1:100 mts

APPROVED BY:

ROSARIO SEGUNDINA P. GAERLAN
REGIONAL DIRECTOR

RECOMMENDING APPROVAL:

SANGHO V. BILOG
REGIONAL SEAWEEDS FOCAL

PROJECT TITLE:

IMPROVEMENT OF SEAWEED
CULTURE LABORATORY

PREPARED BY:

ENGR. GIL D. DE LEON JR.
RESIDENT ENGINEER



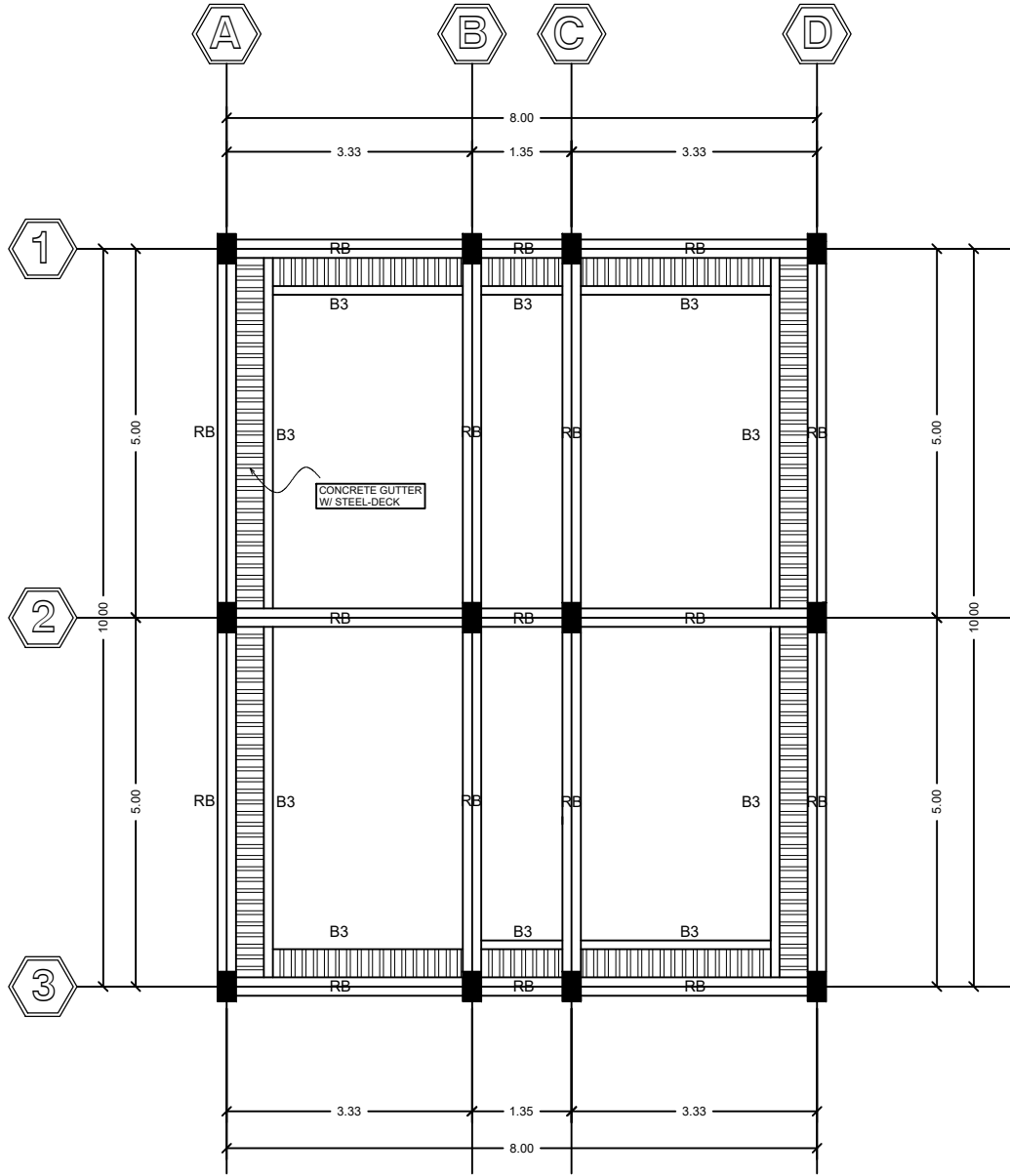

S
46
SCALE 1:100 mts
ROOF BEAM LAYOUT

APPROVED BY:
ROSARIO SEGUNDINA P. GAERLAN
REGIONAL DIRECTOR

RECOMMENDING APPROVAL:
SANGHO V. BILOG
REGIONAL SEAWEEDS FOCAL

PROJECT TITLE:
BANKROVEMENDI HESAWREED
CULTURE LABORATORY

PREPARED BY:
ENGR. GIL D. DE LEON JR.
RESIDENT ENGINEER



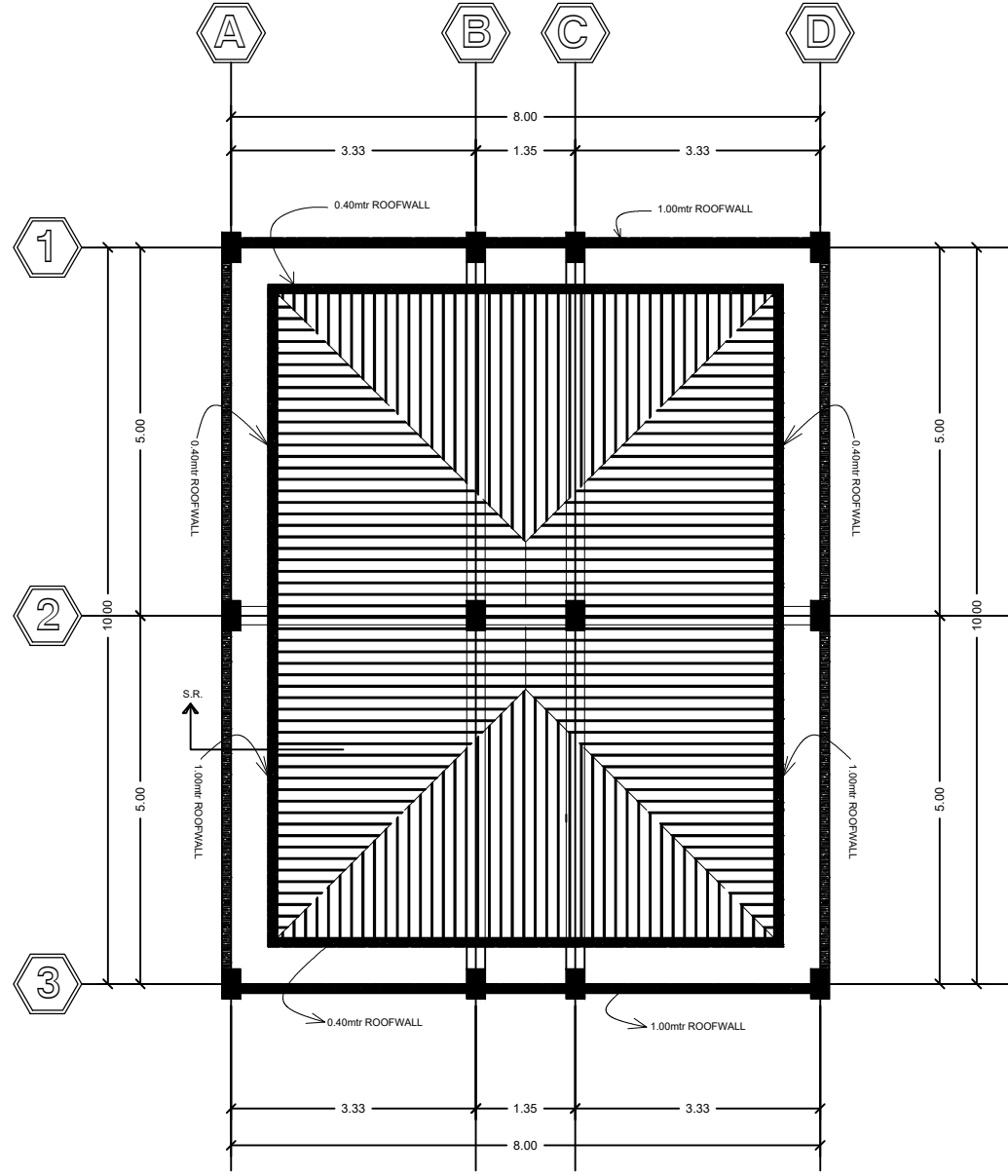



ROOF WALL LAYOUT
 SCALE 1:100 mts

PREPARED BY: ENGR. GIL D. DE LEON JR. RESIDENT ENGINEER	PROJECT TITLE: IMPROVEMENT OF SEAWEED CULTURE LABORATORY	RECOMMENDING APPROVAL: SANGHO V. BILOG REGIONAL SEAWEEDES FOCAL	APPROVED BY: ROSARIO SEGUNDINA P. GAERLAN REGIONAL DIRECTOR
---	--	---	---

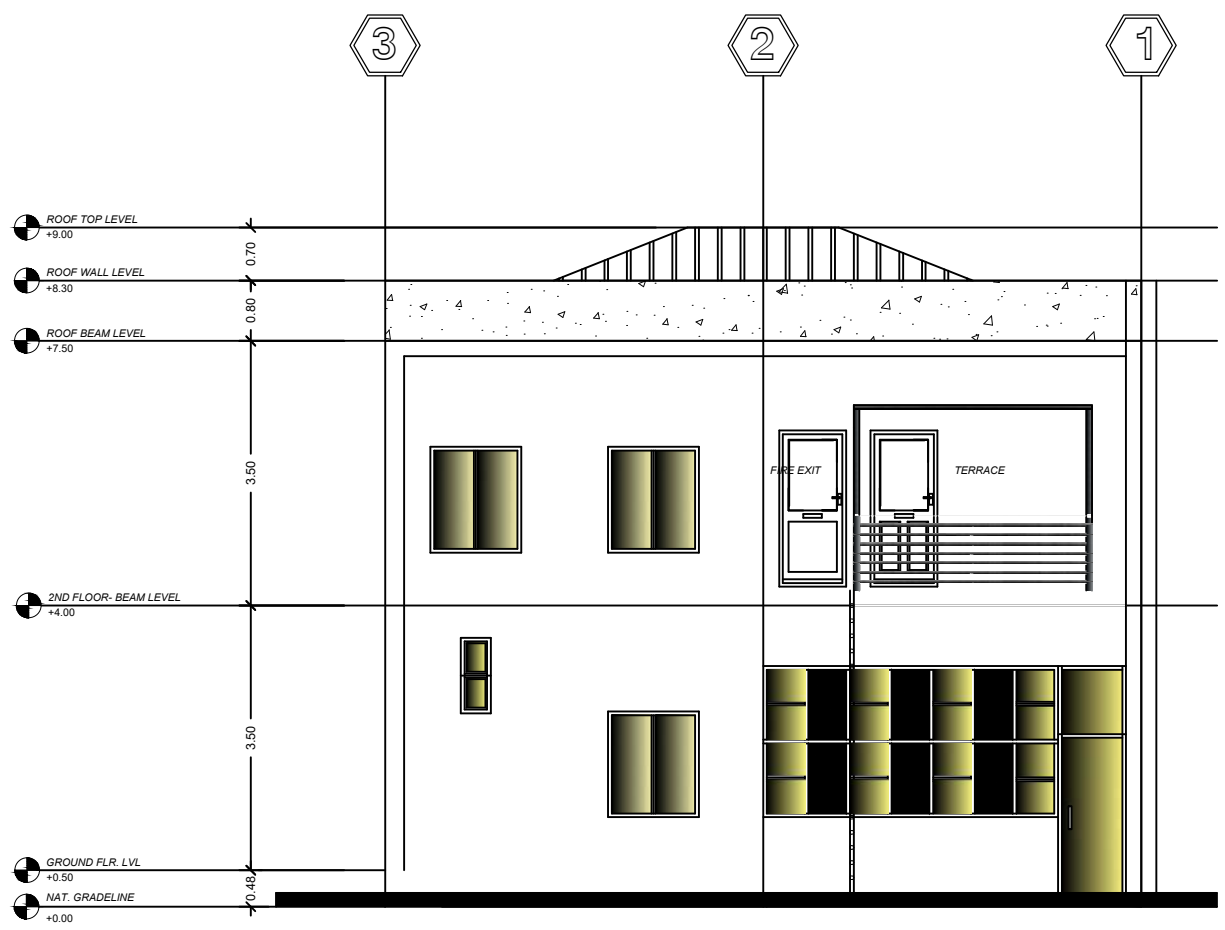



A RIGHT-SIDE ELEVATION
 7/7 SCALE 1:100 mts

APPROVED BY:	ROSARIO SEGUNDINA P. GAERLAN REGIONAL DIRECTOR
RECOMMENDING APPROVAL:	SANGHO V. BILOG REGIONAL SEAWEEDS FOCAL
PROJECT TITLE:	IMPROVEMENT OF SEAWEED CULTURE LABORATORY
PREPARED BY:	ENGR. GIL D. DE LEON JR. RESIDENT ENGINEER



Section VIII. Bill of Quantities



Republic of the Philippines
 DEPARTMENT OF AGRICULTURE
BUREAU OF FISHERIES AND AQUATIC RESOURCES
 Regional Fisheries Office No. 1
 Sevilla, San Fernando City, La Union Telefax: (072) 242-15-59/607-5115
 Email: region1@bfar.da.gov.ph

NAME OF PROJECT : REHAB AND IMPROVEMENT OF THE SEAWEED CULTURE LABORATORY			
LOCATION : Lucap, Alaminos City, Pangasinan			
AMOUNT: P 7,000,000.00			
CONTRACT DURATION: 120 CALENDAR DAYS			
ITEM	DESCRIPTION	QUANTITY	UNIT
I.	MOBILIZATION & SITE WORKS		
	Mobilization	1	lot
	Clearing and Grubbing	1	lot
II.	MASONRY WORKS (includes inside and outside plastering)		
	6" thk. CHB	4,058	pcs.
	4" thk. CHB	4,516	pcs.
	Portland Cement	718	bags
	Washed Sand	70	cu.m.
	Crushed Gravel (3/4")	7	cu.m.
	10 mm \emptyset x 6.0 m. RSB (Grade 33)	572	pcs.
	G.A. #16 G.I. Tiewire	15	kls.
III.	CONCRETE WORKS (include Column Footings, Columns, Beams, Slabs, Staircase)		
	Portland Cement	1180	bags
	Washed Sand	59	cu.m.
	Crushed Gravel (3/4")	142	cu.m.
	Powermix/Sahara Water Proofing Compound (Slab)	92	pck
	Gravel Bedding (3/4")	5	cu.m.
IV.	REINFORCING STEEL WORKS (Grade 40)		
	20 mm \emptyset x 6.0 m. RSB	130	pcs.
	16 mm \emptyset x 6.0 m. RSB	522	pcs.
	12 mm \emptyset x 6.0 m. RSB	227	pcs.
	10 mm \emptyset x 6.0 m. RSB	871	pcs.
	G.A. #16 G.I. Tiewire	49	kls.

ITEM	DESCRIPTION	QUANTITY	UNIT
V.	FORMS AND SCAFFOLDINGS:		
	2"x4"x12' Coco Lumber	250	pcs.
	2"x3"x12' Coco Lumber	752	pcs.
	2"x2"x12' Coco Lumber	2648	pcs.
	1/4' x 4' x 8' Ordinary Plywood	162	pcs.
	4" Common Nails	83	kgs.
	3" Common Nails	83	kgs.
	2" Common Nails	44	kgs.
	1 1/2" Common Nails	18	kgs.
VI.	CEILING WORKS:		
	0.40mm x 5.00 m Metal Furring	243	pcs.
	Furring Clip	800	pcs.
	Blind Rivets	14	boxes
	8.00 mm dia. Deformed Bars	6	pcs.
	0.5mm x 0.15m x 12' Cornice	38	pcs.
	9.0mm x 4' x 8' Gypsum Board	139	pcs.
	Mesh Tape	20	pcs.
VII.	ROOFING WORKS		
	16 ft Rib-type Roofing Sheets	98	pcs.
	4" x 2" C-Purlins	62	pcs.
	4" x 2" Square Tube	30	pcs.
	2 x 1/4 Angle Bar	20	pcs.
	2.4x 18" Box Gutter	18	pcs.
	End Flashing	20	pcs.
	2" teckscrews	5	boxes
	PVC Spandrel Ceiling eaves	1	lot
	Consumables	1	lot
VIII.	PAINTING WORKS (Coverage: ALL SURFACES)		
	Gloss Latex paint	34	pails
	Flat Latex paint	24	pails
	Concrete Neutralizer	10	gals.
	Flat wall Enamel Paint	17	gals.
	Quick Dry Enamel Paint (QDE)	15	gals.
	Concrete Putty	20	gals.
	Paint Thinner	30	gals.
	Paint tray w/ Roller brush 8"	20	pcs.
	4" Paint brush	20	pcs.
	2" Paint brush	20	pcs.
	Drywall Primer	5	gal
	Gypsum Putty	15	gal

ITEM	DESCRIPTION	QUANTITY	UNIT
	#120 Sand Paper	60	pcs.
	Acry Color & Oil Tinting color	10	cans
	Consumables	1	lot
IX.	DECORATIVE STONES, BRICKS AND TILES		
	All decorative stone, bricks, and tiles	1	lot
X.	DOORS & WINDOWS		
	1. Doors		
	Solid Door (D1)	2	sets
	0.70 x 2.10 m PANEL DOOR (D2)	6	sets
	0.60 x 2.10 m PVC Door (D3)	4	sets
	2. Windows		
	1.20 x 1.00 Window 1 (AW1)	10	units
	1.00 x 0.70 Window 2 (AW2)	2	unit
	0.80 x 0.50 Window 3 (AW3)	2	unit
	1.20 x 0.50 Window 3 (AW3)	2	unit
XI.	TILEWORKS		
	0.60 x 0.60m. Vitrified Tiles	432	pcs.
	0.60 x 0.60m. Vitrified Tiles (CR floor)	18	pcs.
	0.60 x 0.60m. Vitrified Tiles (CR walls)	100	pcs.
	Tile trim	3	pcs.
	Stair Tile trim (Rubberized)	25	pcs.
	Adhesive Cement	72	bags
	Washed Sand	6	cum
	Tile grout	22	kls.
XII.	PLUMBING WORKS		
	A. Plumbing Fixtures and Fittings		
	Lumpsum for plumbing fixtures, fittings (Labor & mat'ls)	1	lot
	B. Plumbing Accessories		
	Water Closet complete with accessories	2	sets
	Lavatory complete w/ accessories	2	sets
	Kitchen Sink w/ accessories	1	set
	Urinals	2	sets
	Shower set	2	sets
	Consumables	1	lot
	C. Plumbing Equipment		
	2 hp Jetpump	1	set

ITEM	DESCRIPTION	QUANTITY	UNIT
	Jetmatic Manual Water Pump	1	set
XIII.	ELECTRICAL WORKS		
	A. Panelboards and Breakers (MATERIALS & LABOR)		
	Circuit Breaker Panel		
	Main - 50AT, 100AF, 2 Pole	1	lot
	Branches: 2 - 15 AT, 60 AF, 2 Pole		
	1 - 20 AT, 60 AF, 2 Pole		
	B. Wires & Cables (MATERIALS & LABOR)		
	14.0 mm ² THHN Copper Conductor	20	mts.
	3.5 mm ² THHN Copper Conductor	1	roll
	2.0mm ² THHN Copper Conductor	1	roll
	C. Conduits, Fittings & Accessories		
	32 mm \varnothing x 3.0 m.l. PVC Pipe	2	pcs.
	15 mm \varnothing x 3.0 m.l. PVC Pipe	84	pcs.
	Weatherhead Entrance Cap	1	sets
	D. Lighting Fixtures		
	Compact Recessed Type w/ Mirrorized Fluorescent Pinlight (1x18W), 6" dia.	38	sets
	E. Wiring Devices		
	2-Gang Convenience Outlet, Universal	25	sets
	Aircon Outlet, Universal	8	sets
	2-Gang Switch	12	sets
	F. Boxes, Connectors & Fittings		
	Utility Box, Ga # 16, 2" x 4"	37	pcs.
	Junction Box, Ga # 16, 4" x 4"	41	pcs.
	Other fittings & Consumables	1	lot
XIV.	SEPTIC TANK (3.6 x 1.4 m)		
	4" x 8" x 12" CHB	394	pcs.
	Portland Cement	44	bags
	Washed Sand	8.37	cu.m
	Gravel	2.97	cu.m
	10 mm \varnothing x 6.0 m. RSB	73	pcs.
	G.A. #16 G.I. Tiewire	4.9	kl
XV.	EXCAVATION WORKS		
	FOUNDATION EXCAVATION (Footing, Wall Footing, and Septic Tank)	1	lot

<i>ITEM</i>	<i>DESCRIPTION</i>	<i>QUANTITY</i>	<i>UNIT</i>
XVI.	BACKFILL (Ground Floor Slabs and Stairs)		
	Earthfill	100	cu.m
	Soil Treatment	100	sq. m
XVII.	TERRACE & GARAGE		
	Terrace		
	2"x 2"x 1.2mm Square Tube	4	pcs
	1"x 1" x 1.2mm Square Tube	10	pcs
	Consumables	1	lot
	Garage		
	16 ft Rib-type Roofing Sheets	36	pcs.
	2.4 m Bent flat sheet flashing	6	pcs.
	4" x 2" C-Purlins	14	pcs.
	2" dia.x 6m G.I. Pipe	6	pcs.
	3" dia. X 6m G.I. Pipe	3	pcs.
	2" x 1/4 Angle Bar	2	pcs.
XVII.	PREPARATION		
	Temporary Facilities	1	lot
XVIII.	ESTIMATED GOVERNMENT EXPENDITURES:		
	Engineering and Administrative	1	lot
	Direct Engineering Expenditures	1	lot
	All Required Permits for the Project	1	lot

Section IX. Checklist of Technical and Financial Documents

Checklist of Technical and Financial Documents

I. TECHNICAL COMPONENT ENVELOPE

Class "A" Documents

Legal Documents

- (a) Valid PhilGEPS Registration Certificate (Platinum Membership) (all pages) in accordance with Section 8.5.2 of the IRR;

Technical Documents

- (b) Statement of the prospective bidder of all its ongoing government and private contracts, including contracts awarded but not yet started, if any, whether similar or not similar in nature and complexity to the contract to be bid; **and**
- (c) Statement of the bidder's Single Largest Completed Contract (SLCC) similar to the contract to be bid, except under conditions provided under the rules; **and**
- (d) Special PCAB License in case of Joint Ventures **and** registration for the type and cost of the contract to be bid; **and**
- (e) Original copy of Bid Security. If in the form of a Surety Bond, submit also a certification issued by the Insurance Commission **or** original copy of Notarized Bid Securing Declaration; **and**
- (f) Project Requirements, which shall include the following:
- a. Organizational chart for the contract to be bid;
 - b. List of contractor's key personnel (*e.g.*, Project Manager, Project Engineers, Materials Engineers, and Foremen), to be assigned to the contract to be bid, with their complete qualification and experience data;
 - c. List of contractor's major equipment units, which are owned, leased, and/or under purchase agreements, supported by proof of ownership or certification of availability of equipment from the equipment lessor/vendor for the duration of the project, as the case may be; **and**
- (g) Original duly signed Omnibus Sworn Statement (OSS) **and** if applicable, Original Notarized Secretary's Certificate in case of a corporation, partnership, or cooperative; or Original Special Power of Attorney of all members of the joint venture giving full power and authority to its officer to sign the OSS and do acts to represent the Bidder.

Financial Documents

- (h) The prospective bidder's computation of Net Financial Contracting Capacity (NFCC).

Class "B" Documents

- (i) If applicable, duly signed joint venture agreement (JVA) in accordance with RA No. 4566 and its IRR in case the joint venture is already in existence **or** duly notarized statements from all the potential joint venture partners stating that they will enter into and abide by the provisions of the JVA in the instance that the bid is successful.

II. FINANCIAL COMPONENT ENVELOPE

- (j) Original of duly signed and accomplished Financial Bid Form; **and**

Other documentary requirements under RA No. 9184

- (k) Original of duly signed Bid Prices in the Bill of Quantities; **and**
- (l) Duly accomplished Detailed Estimates Form, including a summary sheet indicating the unit prices of construction materials, labor rates, and equipment rentals used in coming up with the Bid; **and**
- (m) Cash Flow by Quarter.

